



HTR-RF(20) THERMOSTAT - FULL USER MANUAL



TABLE OF CONTENTS

1. Introduction	5
1.1 Product Compliance	5
1.2 Safety Informations	5
2. Product Overview	6
2.1 Montage	6
2.2 Package content	6
2.3 Proper thermostat location	6
2.4 Connection Description (HTR-RF(20) thermostat)	6
2.5 Mounting and installation of the thermostat	7
3. About ZigBee network	8
3.1 ZigBee network - creation and work	8
3.2 Compatibility with SALUS devices (ONLINE AND OFFLINE)	9
4. Before you start (first power up)	10
4.1 General informations	10
4.2 LED diode indications	10
4.3 First power up sequence and preparing to the pair process	11
5. Installation by SALUS Smart Home application (ONLINE MODE)	12
5.1 General informations about SALUS Smart Home application	12
5.2 Pairing with underfloor heating wiring centre (KL08RF/Control Box)	13
6. OPERATING in ONLINE MODE (by app)	16
6.1 General informations	16
6.2 App icons description	16
6.3 Change thermostat name (pencil icon)	17
6.4 Setpoint temperature change	18
6.5 Heat/Cool mode change (KL08RF connection)	19
6.6 Thermostat modes	20
6.6.1 Schedule mode	20
6.6.2 Temporary override mode	24
6.6.3 Manual mode	24
6.6.4 Frost protection	25
6.7 Compatibility with window/door sensor OS600 / SW600	26
6.8 Compatibility with Smart Plug SPE600	27
6.9 Compatibility with Smart Relay SR600	28
6.10 Identification mode	29
6.11 Pinning/unpinning thermostat to/from application dashboard	30
6.12 User settings (basic settings)	31
6.13 Admin settings (installer parameters)	32
6.14 OneTouch rules (add/edit)	33
6.15 Error codes (exclamation mark in app)	37
6.16 Wireless signal strength test	38
6.17 Factory reset (removing thermostat from the app and ZigBee network)	39
7. Installation in OFFLINE MODE without SALUS SmartHome application	41
7.1 General informations	41
7.2 Pairing with underfloor heating wiring centre (KL08RF/Control Box)	42
7.2.1 Available operation modes	42
7.2.2 Pairing with underfloor heating wiring centre (KL08RF/Control Box) and installation of the thermostat as a group thermostat - SLAVE	45

8. OPERATING in OFFLINE MODE	47
8.1 Heat/cool mode change (KL08RF connection).....	47
9. Battery change	48
10. Factory reset	48
11. Cleaning and Maintenance	49
12. Technical Informations	49
13. Warranty	50

1. Introduction

1.1 Product Compliance

This product complies with the essential requirements and other relevant provisions of Directives 2014/53/EU and 2011/65/EU. The full text of the EU Declaration of Conformity is available at the following internet address: www.saluslegal.com.

1.2 Safety Informations

- Before starting installation work and before using the product, read the entire manual.
- The information contained in the instructions is essential for proper functioning.
- To avoid accidents resulting in personal injury and material damage, please follow all safety precautions, specified in this manual.
- The device should not be used by people with limited mental, sensory or mental abilities, without experience, of insufficient knowledge as well as children.
- Do not use an unassembled device (eg without a cover).
- The device may only be opened by a qualified person.
- Keep electrical devices out of the reach of children and ensure that they do not play with it. Children should not be left unattended. If necessary, disconnect the control system for the entire room.
- Do not leave the packaging, cabinet, or any loose parts of the device unattended, as they pose a risk to children.

WARNING!

- Installation must be carried out by a qualified person with appropriate electrical qualifications in accordance with standards and regulations in force in the given country and in the EU.
- Never try to connect the device other than as described in the manual.
- Before assembly, repair or maintenance as well as during any connection works it is absolutely necessary disconnect the mains supply and make sure that the terminals and electric wires are not live.
- The device may not be exposed to extreme temperatures, strong vibrations or subjected to mechanical shock.
- The device should not be used in unfavorable environmental conditions or in rooms where there is a concentration of flammable gases, fumes or dust.

WARNING!

- There may be additional protection requirements for the entire installation that the installer is responsible for maintaining.



Care for the natural environment is of paramount importance to us. The awareness that we manufacture electronic devices obliges us to dispose of used electronic components and devices safely. Therefore the company has received a registration number issued by the Chief Inspector for Environmental Protection. The crossed out symbol the trash can on the product means that the product must not be disposed of with ordinary waste containers. Sorting waste for recycling helps to protect the environment. It is the user's responsibility to surrender used equipment to a designated collection point for recycling waste from electrical and electronic equipment.

2. Product Overview

HTR-RF(20) is a surface-mounted room thermostat. The wireless control of heating only with the KL08RF wiring centre. In combination with Universal Gateway UGE600 this regulator can be controlled over the Internet using SALUS SmartHome app (Online mode). Without Internet connection (Offline mode) thermostat works locally, but its communication with other devices must be done through the coordinating unit - C010RF.

2.1 Montage

2.2 Package content

- 1) HTR-RF(20) thermostat
- 2) 2x AA batteries
- 3) Short instruction
- 4) Mounting screws



2.3 Proper thermostat location

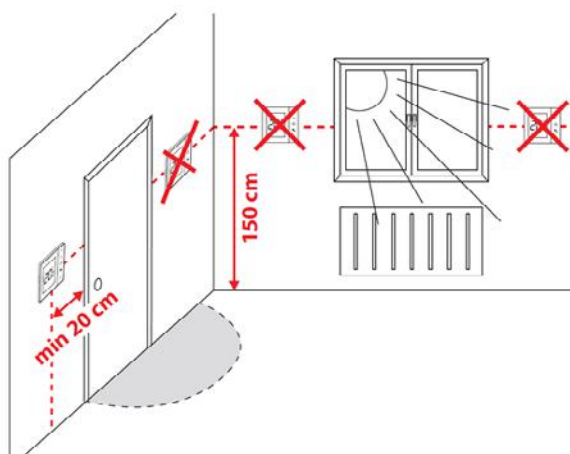

Please note:

The ideal position to thermostat mounting is about 1,5m under floor level far from heating or cooling sources. Thermostat can't be exposed to sunlight or any extreme conditions like for example draft.

Because of fire and explosion risk there is not allowed to use thermostat in atmosphere of explosive gases and flammable liquids (eg coal dust). In case if any of listed dangers occur you have to use additional protection measures – anti-dust and explosive gases (tight cover) or prevent their formation. Furthermore, thermostat can't be used in condensation of water vapor conditions and be exposed to water action.

2.4 Connection Description (HTR-RF(20) thermostat)

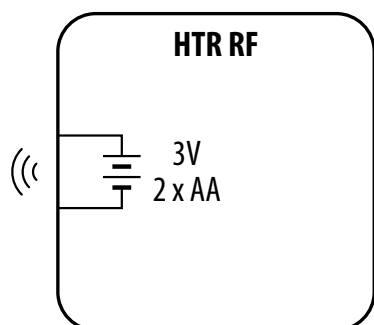

Symbols explanation:

	Description
Power supply	2 x AA batteries
(((Wireless connection

2.5 Mounting and installation of the thermostat



Remove back cover.



Mount the back cover to the wall using screws included with the set.

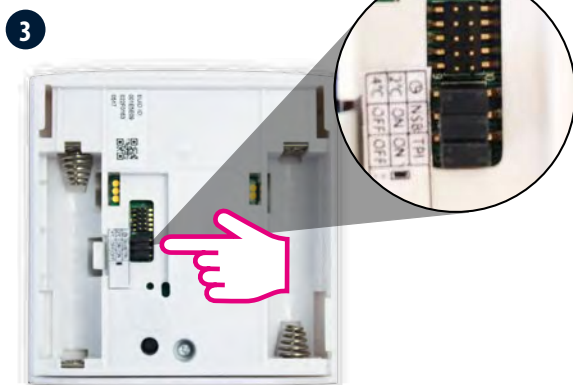

Adjust the settings with the jumpers.

⊖	NSB	TPI	
2°C	ON	ON	■
4°C	OFF	OFF	:

Jumper on ■

Jumper off :

Jumper	Function	Default
TPI*/Hysteresis	TPI (jumper on) or Hysteresis 0.5°C (jumper off)	TPI on
NSB function**	NSB on (jumper on) or off (jumper off)	On
NSB temperature decrease value***	-2°C (jumper on) or -4°C (jumper off)	-2°C for heating mode +2°C for cooling mode

*TPI is a built-in energy-saving control algorithm that ensures a stable temperature in the rooms.

**The NSB function is only available if the system is equipped with at least one weekly programmable thermostat (master). There is no need to remove the jumper in case there is no master thermostat.

***If a programmable thermostat (master) is connected to the system and the NSB function is active, the HTR-RF(20) thermostat will automatically adjust the temperature decrease value according to the jumper settings.

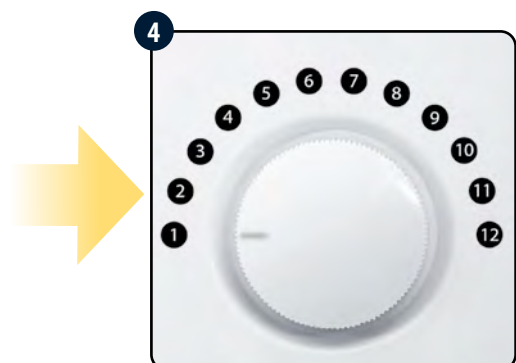

Make sure the thermostat knob is in position 1.



Then insert the batteries. When done, place the thermostat on the back cover that is attached to the wall.

3. About ZigBee network

3.1 ZigBee network - creation and work

ZigBee is a wireless network based on IEEE 802.15.4 standard and its communication takes place in the 2.4 GHz band. The network is based on a mesh topology, which allows for a very large range and high reliability. The maximum range of direct communication between two network nodes (devices) is about 100m in open space.

The devices included in the ZigBee network are divided into three types:

- **coordinator** - there can only be one such device in each network. It acts as a connection node for all devices;
- **router (repeater)** - this device is powered by 230VAC, with functionality similar to classic network routers, and its task is to forward data packets and increase the range of the network;
- **terminal device** - battery powered, sends data to the coordinator (also through the router) to which it is connected. It is usually put to sleep temporarily, which helps reduce energy consumption.

Built-in security in the ZigBee protocol (ISO-27001 and SSAE16 / ISAE 3402 Type II - SOC 2 certification) ensure high transmission reliability, detection and removal of transmission errors, as well as connectivity between established priority devices.

Security measures include:

- devices authenticated using a unique key pair;
- encrypted communication between the mobile application and the device;
- data encryption - HTTPS encrypted using TLS, UDP channel with AES-128 encryption;
- layered access control to prevent tampering with one device threatening the entire system.

The ability to work many devices at a short distance from each other was achieved through the use of radio transmission of the spread spectrum signal. The main advantages of devices working in the ZigBee system are two-way communication and minimization of energy consumption, which in many cases allows them to be powered from chemical cells (alkaline batteries).

Four Simple steps to create ZigBee network:

1.

Coordinator Installation - Universal Gateway for **ONLINE** and **OFFLINE** systems with internet application or **CO10RF** for only **OFFLINE** systems without application.



2.

Now - add any device you want **powered 230VAC**.
Note to locate it as near coordinator as possible.

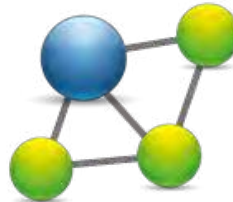

3.

Now you can increase range of ZigBee network by adding more devices **powered 230 VAC**.

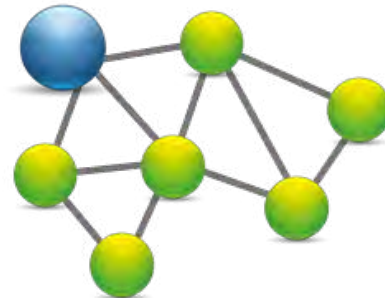

4.

To extend your network you can add more battery devices and accessories.

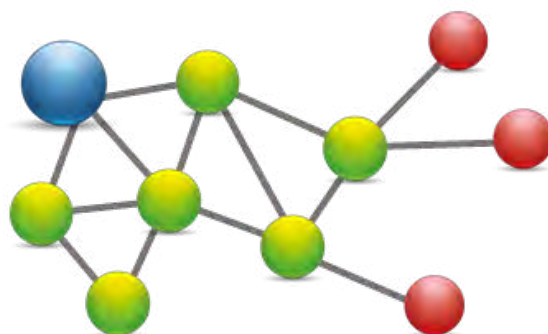

3.2 Compatibility with SALUS devices (ONLINE AND OFFLINE)

COMPATIBILITY WITH OTHER SALUS CONTROLS DEVICES

HTR-RF(20) thermostat can work in **ONLINE** or **OFFLINE** mode.

At first step you need to decide in which mode your thermostat will work.

ONLINE MODE

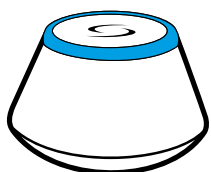

Universal Gateway is CONNECTED TO THE INTERNET
You can configure and use all your devices in the Smart Home App

Download the Smart Home App on your iOS or Android device for remote access to your SALUS equipment.



SALUS Smart Home



OFFLINE MODE

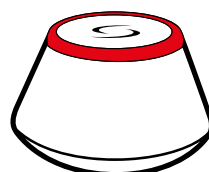

Universal Gateway is NOT CONNECTED TO THE INTERNET

You can use your devices locally without the SmartHome App. Gateway works in this mode as standard ZigBee coordinator.

OR

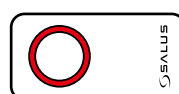

CO10RF Coordinator - You can use standard ZigBee network coordinator to install and use your devices.

Compatible devices:



SR600
Smart Relay



SPE600
Smart Plug



KL08RF wireless wiring centre for 8-zone underfloor heating.



KL04RF extension



RX10RF
receiver

Only in Online Mode through OneTouch rule (cannot pair directly)

RX10RF reacts to HTR-RF(20) signal automatically, when it is paired with KL08RF wiring centre in heating mode. It's not possible to pair directly HTR-RF(20) with RX10RF.

Other SmartHome devices/accessories



Window/door Sensor
SW600 or **OS600**



Smoke detector
SD600



Double/single OneTouch button
SB600/CSB600



Water leak sensor
WLS600



RS600
Roller shutter



RE600
ZigBee network signal repeater (only with UGE600)



RE10RF
ZigBee network signal repeater

4. Before you start (first power up)

4.1 General informations

i For reference only. The illustration on the left (pictures below) explains the relationship between the temperature scale and the scale from instructional sticker. It is useful in the configuration process or in case of a connection loss error. It is recommended to keep the sticker until installation is complete.

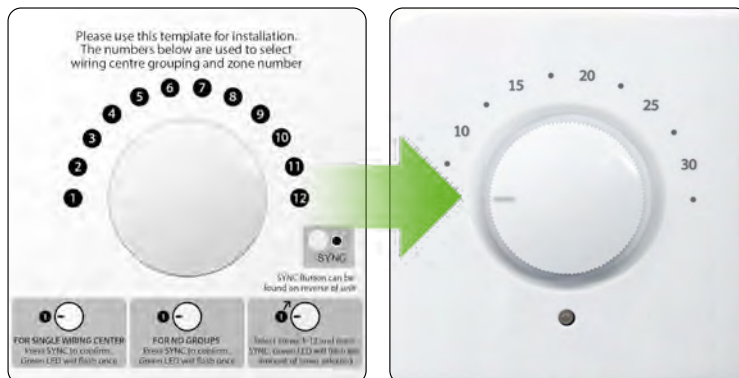

4.2 LED diode indications

LED diode	Description
●●● ●●● ...	Network search (sequentially flashing 3 times red)
—	Successful adding to the network (LED is constantly red)
●	Pairing complete (one green flash)
●, ●●, ●●● ...	Confirmation of the wiring centre number (the number of flashes means the individual number of the wiring centre)
●, ●●, ●●● ...	Confirmation of the group number (the number of flashes means the individual group number)
●, ●●, ●●● ...	Confirmation of the zone number (the number of flashes means the individual zone number)
●●●●●●●● ...	Identification process enabled (green LED flashing)
●●●●●●●● ...	Lost connection with CO10RF, KL08RF, UGE600 (red LED flashing)
●●● ●●● ...	Low battery (fast flashing 3 times every 10 seconds)
●●●●●●●● ...	Error when installing the thermostat - signaling of an occupied zone in the wiring centre by another thermostat or adding to a non-existent wiring centre in the network (alternating red and green diodes blinking)
—	Signaling of the restoration of factory settings after a longer pressing of the SYNC button (the orange diode will light for a second)

4.3 First power up sequence and preparing to the pair process

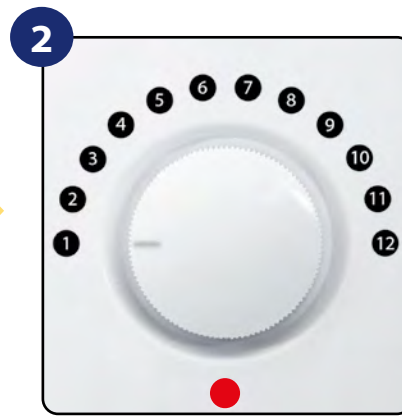
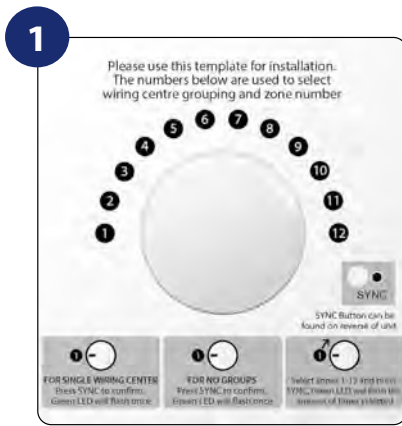

Before pairing process do not remove instructional sticker (it might be helpful during pairing in offline mode). After removing back cover insert 2xAA batteries, pay attention to the batteries polarity.

Thermostat will power up. If it's already paired then green diode will blink once...

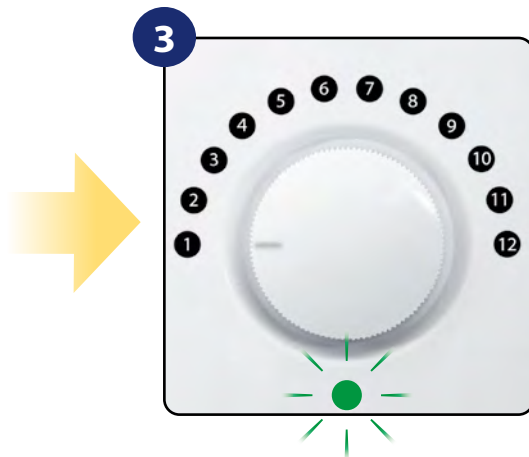

...if thermostat is not paired then LED diode will blink alternately green/red showing the firmware version...

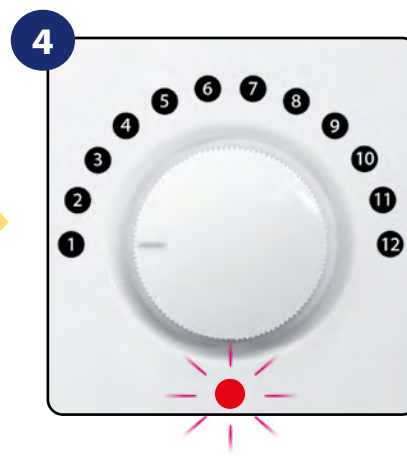

...after all red diode will start to blink 3 times in a row sequentially, which means that thermostat is in pairing mode.

5. Installation by SALUS Smart Home application (ONLINE MODE)

5.1 General informations about SALUS Smart Home application

Thanks to UGE600 Universal Gateway and SALUS Smart Home app system allows you to remote control of your heating system in any place you are in the moment by smartphone, tablet or computer with Internet connection. Then you have also access to advanced functions of HTR-RF(20) thermostat. You can also create OneTouch rules to customize system to your needs.

- 1 First make sure that you have downloaded the Salus Smart Home App from the Google Play or App Store. You will need to follow a few easy steps to create an account and then link your thermostat to the Universal Gateway and to the App.

You can also access the web version on:
<http://eu.salusconnect.io/>



2



To begin the pairing process the Gateway should be plugged into the power supply and connected to the Internet. Also, make sure that the UGE600 is added to your Salus Smart Home App. For the installation of the Universal Gateway, please refer to the UGE600 manual on salus-manuals.com

3



Make sure that your UGE600 Universal Gateway is added to the App. The LED of the Gateway should be steady blue. Then go to HTR-RF(20) thermostat and begin pairing process with the UGE600 and add it to the App.

5.2 Pairing with underfloor heating wiring centre (KL08RF/Control Box)



Please note:

For easier installation, please make sure you have already added underfloor heating wiring centre (KL08RF/Control Box) to your ZigBee network (please refer to the underfloor heating wiring centre manual instruction).

1



Press SYNC button (back of the thermostat) for 5 seconds...

2

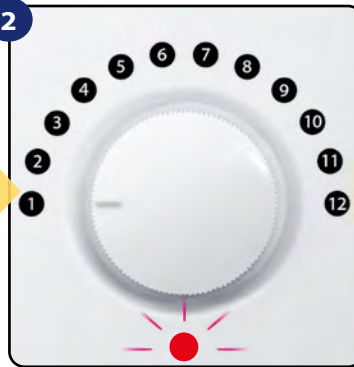

...red diode will start to blink 3 times in a row sequentially.

3



Go to SALUS Smart Home app.

4

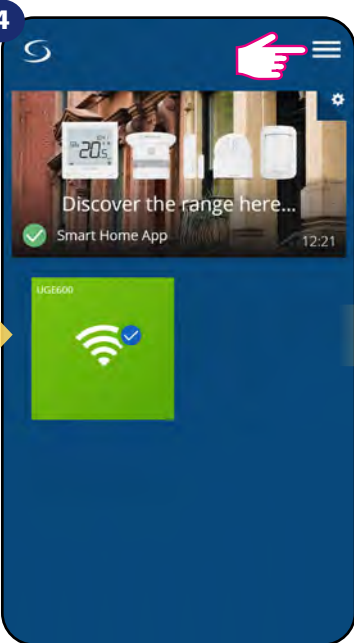

Open main menu.

5

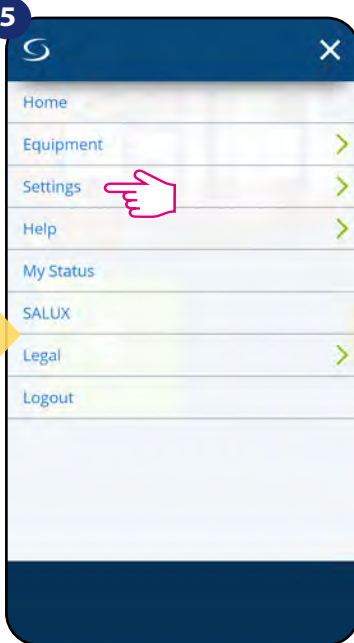

Select „Settings“.

6

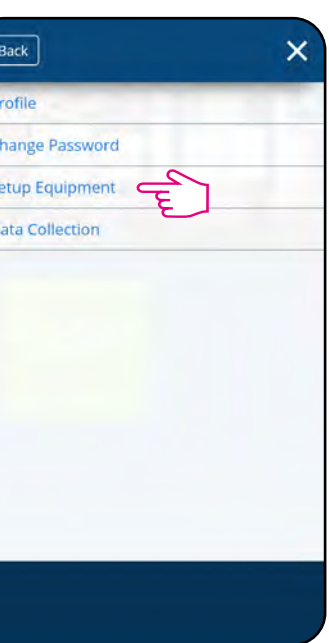

Now enter to the „Setup Equipment“.

7

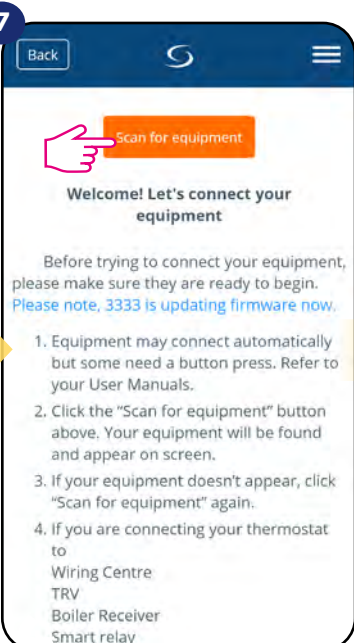

Press „Scan for equipment“ button.

8

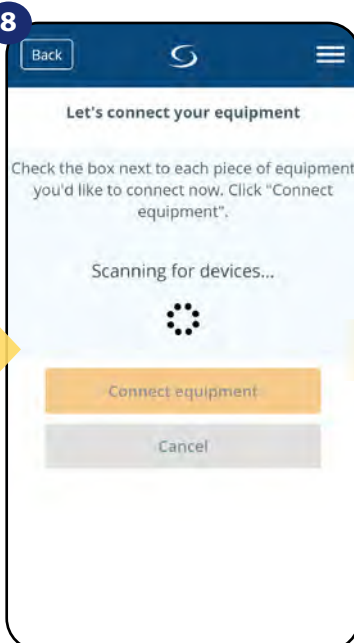

App has started scanning...

9

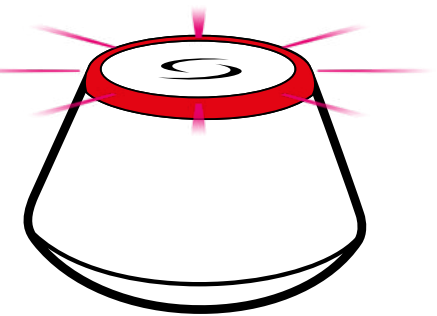

...Gateway has started flashing red and searching for the thermostat...

10



Diode will flash constantly red.
Thermostat is connected. Go to the
Smart Home app to configure it.

11

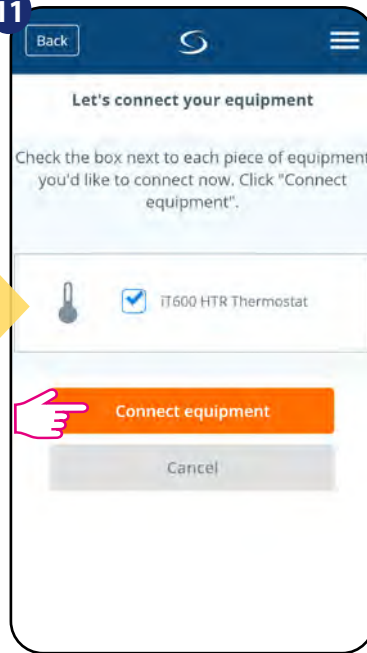

Select your thermostat and press
„Connect equipment“ button.

12

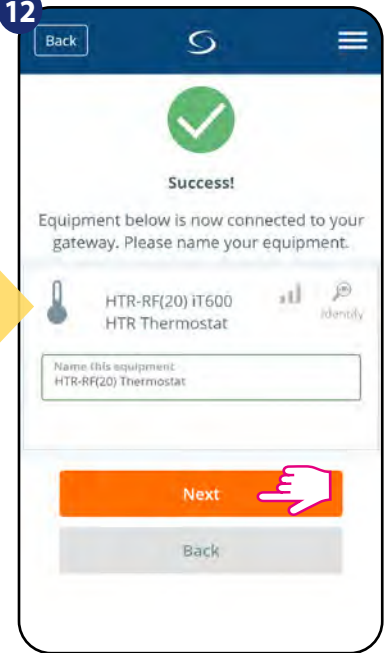

Name your thermostat and go
„Next“...

13

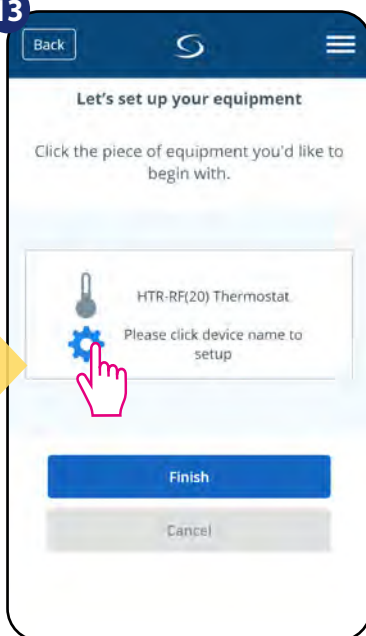

Press gear icon.

14

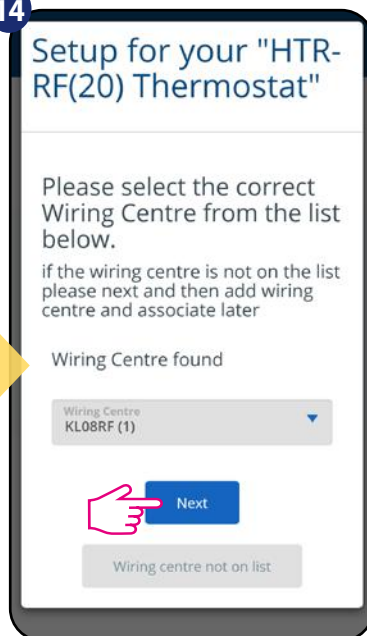

Select your KL08RF/Control Box
added before.

15

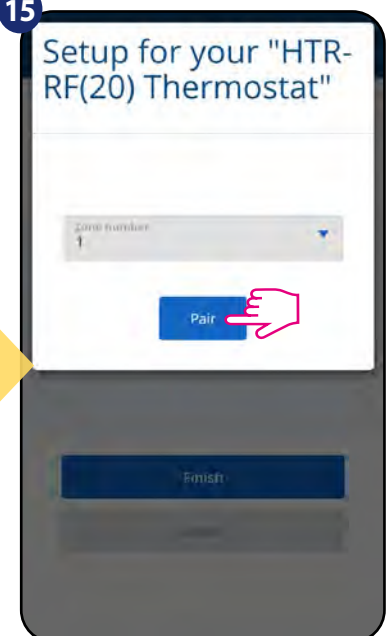

Select the zone which you want
attribute to your thermostat.

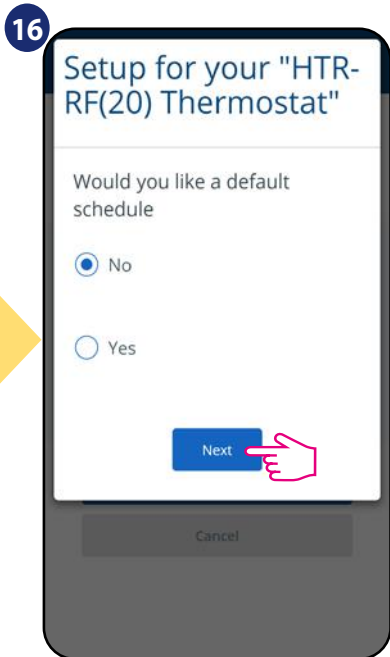

Choose „No” if you want to set your own schedule later or „Yes” if default now.

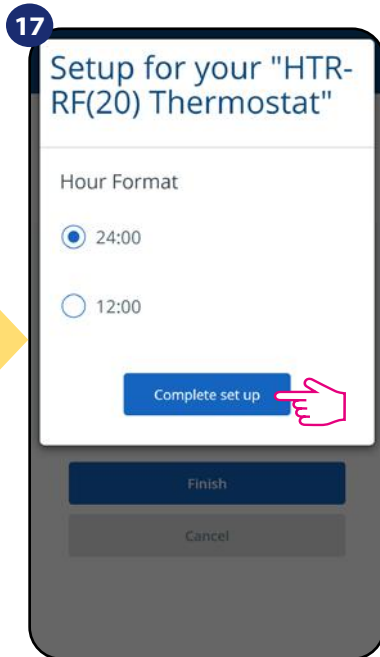

Select hour format (24H/12H) and confirm by „Complete set up” button.

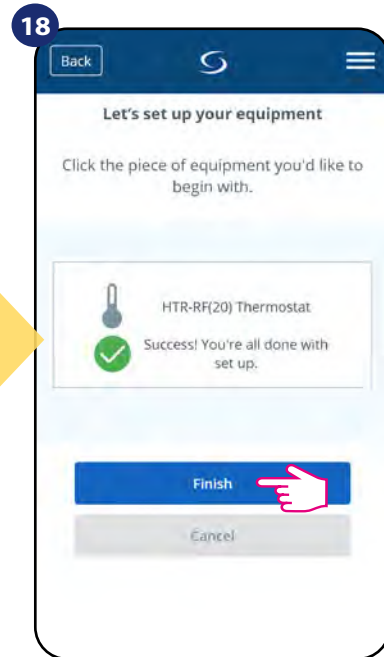

Press „Finish” button to end the setup process in the app.

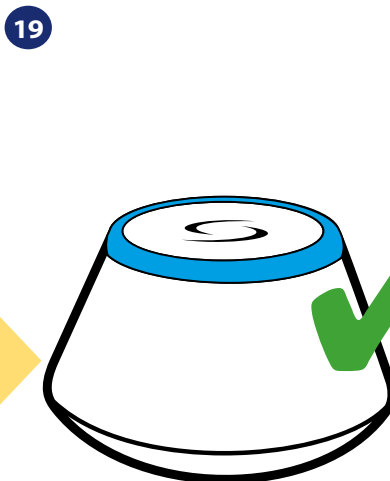

Gateway stop flashing and turn to steady blue color which means pair process has been finished.



After that thermostat is ready for work. You successfully configured HTR-RF(20) thermostat with KL08RF Control Box.

6. OPERATING in ONLINE MODE (by app)

6.1 General informations

This section will show how to use your **HTR-RF(20) thermostat** with the **UGE600 Universal Gateway** and the **Salus Smart Home App**. In order to do that, you will need a **Salus UG600/UGE600 Universal Gateway**, the **Salus Smart Home App** and **Internet connection**. Controlling your thermostat via the App gives you a lot of freedom and the possibilities to manage the temperature in your house/office remotely (Smart Home app is available for Android/iOS mobile devices or Internet browser).

6.2 App icons description

Menu view of HTR-RF(20) thermostat set as a programmable thermostat in **SALUS SmartHome** application:

Thermostat name

Thermostat name change tool

Setpoint temperature

Setpoint temperature slider

Room temperature

Thermostat Heat/Cool mode indicator

Identification tool

Thermostat mode selection

Icons of devices like window / door sensors (OS600/SW600), Smart Plug (SPE600) and SR600 smart relay. You can see them only when these devices are paired with system. Through these icons you can pair HTR-RF(20) thermostat fast with selected device.

Pin/Unpin thermostat to/from main application dashboard

Additional thermostat settings (including advanced installer parameters)

Information	
Connected	Online
Model	HTR-RF(20)
Pair with	Wiring Centre #1

6.3 Change thermostat name (pencil icon)

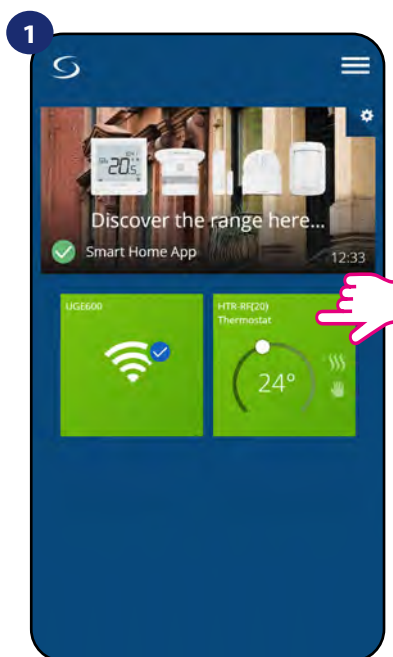

Select the thermostat in the main app menu.

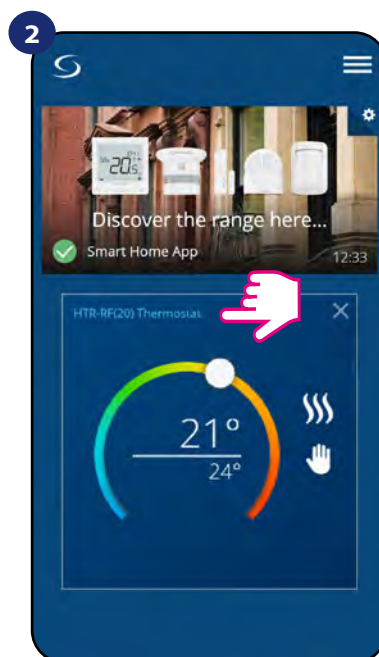

Press the thermostat's name.

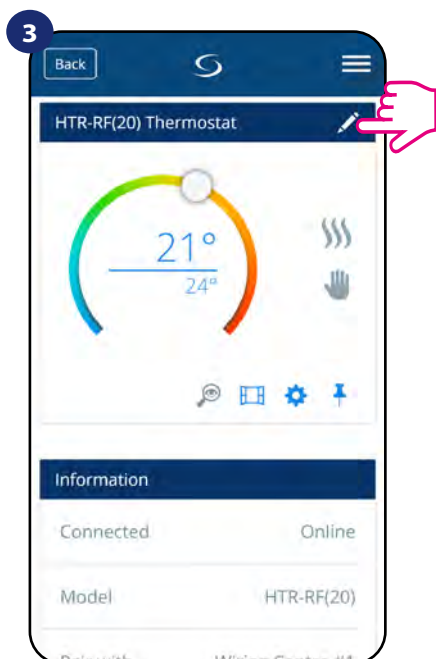

Click on the pencil icon.

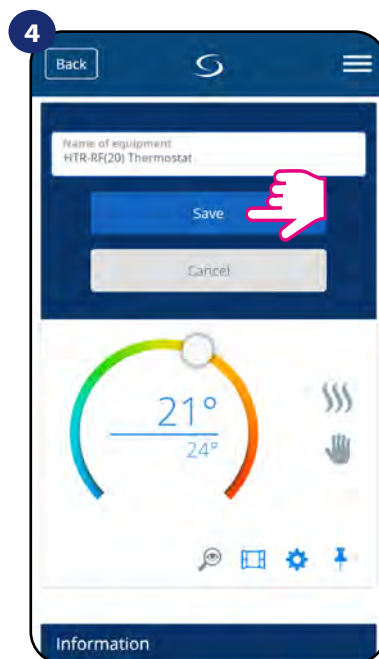

Name your thermostat and confirm it by „Save” button.

6.4 Setpoint temperature change

You can change the setpoint by sliding the cursor to left/right on your App. On your App screen, the setpoint temperature is the number displayed in a larger font.

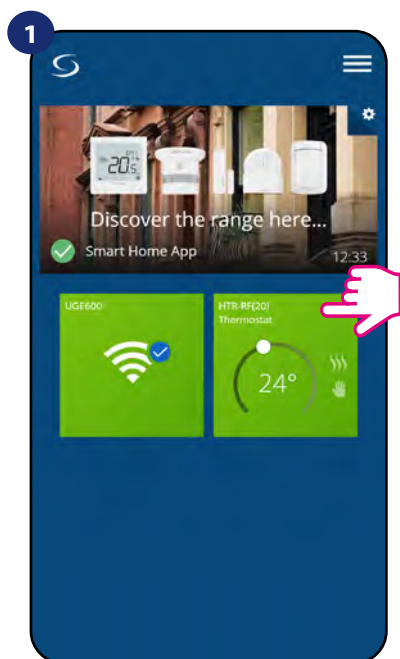

Select the thermostat in the main app menu.

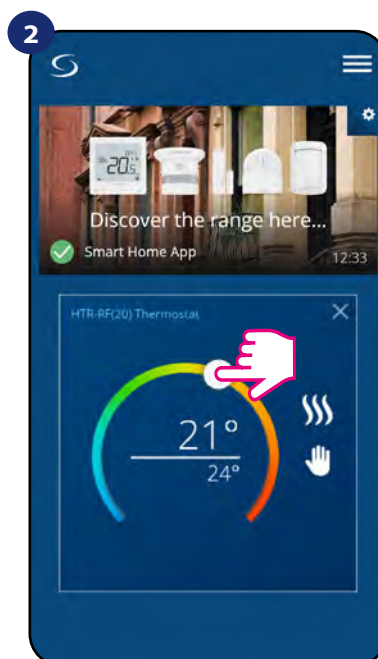

Old setpoint value.

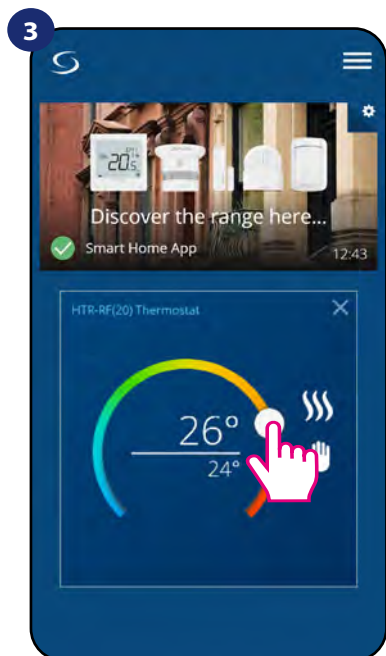

New setpoint value.

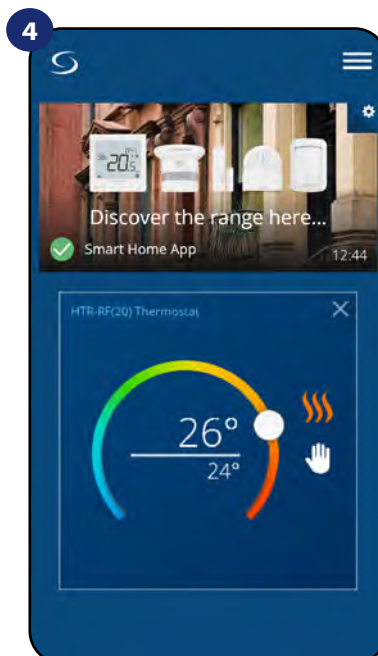

Thermostat has started heating (flame icon changed colour from white to orange).

6.5 Heat/Cool mode change (KL08RF connection)

HTR-RF(20) thermostat could be a heating device or cooling device. **Default thermostat is set for heating.** To set cool mode you have to insert the jumper into „CO” terminal on KL08RF side. Look at the instructions below:

HEATING MODE:

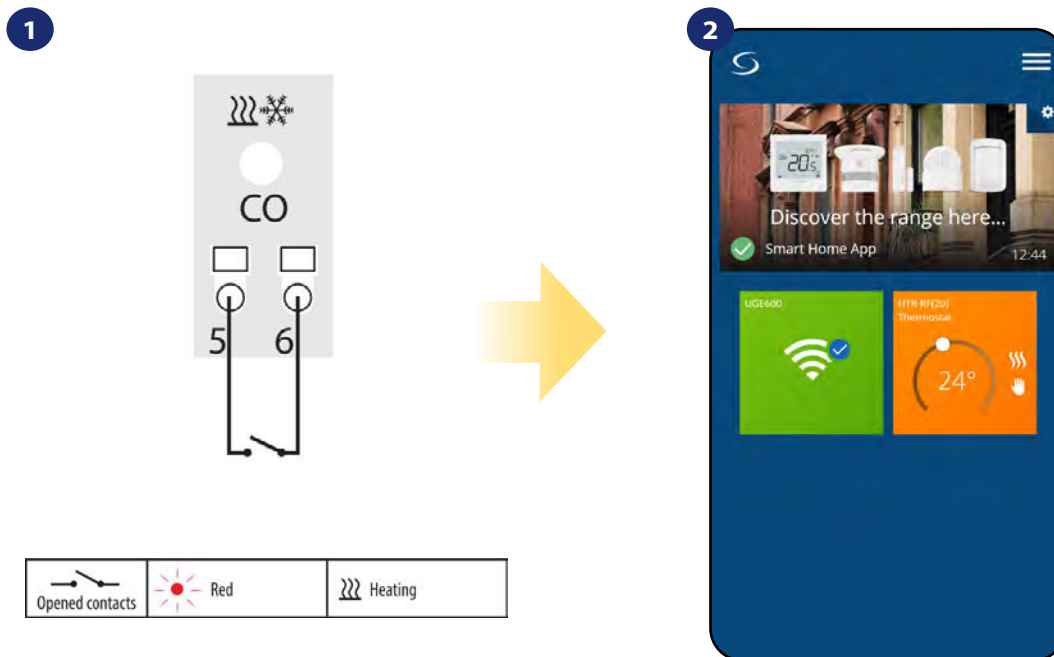

When there is no jumper at „CO” terminal KL08RF is automatically working in heating mode.

In the application you will see orange thermostat tile with „Flame” icon when heating mode is on.

COOLING MODE:

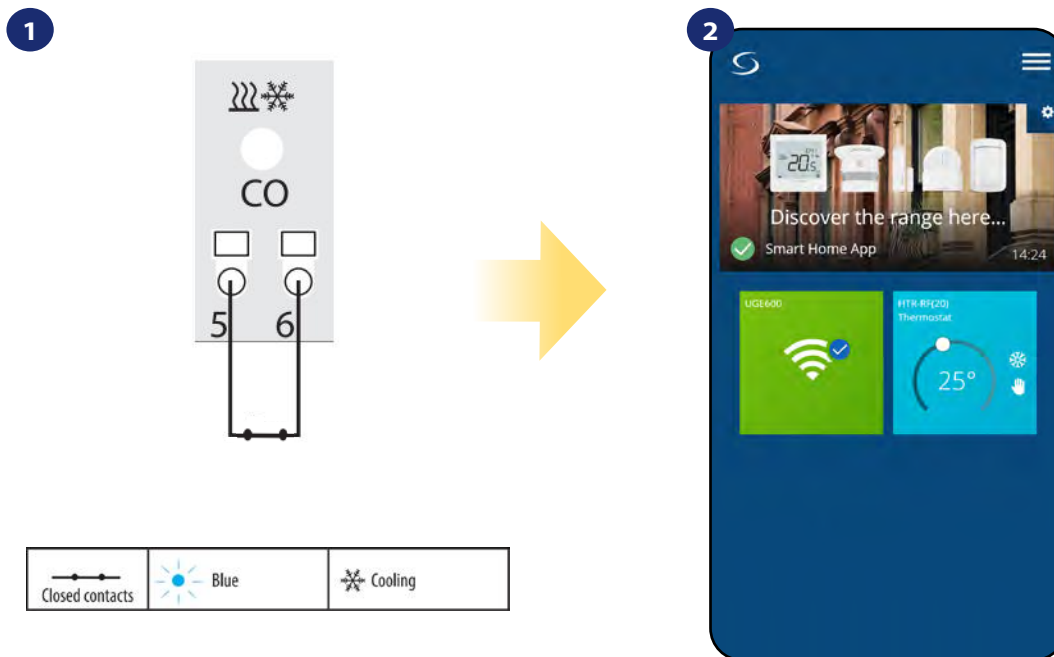

When there is jumper at „CO” terminal KL08RF is automatically working in cooling mode.

In the application you will see blue thermostat tile with „snowflake” icon when cooling mode is on.

6.6 Thermostat modes

6.6.1 Schedule mode

The **HTR-RF(20) thermostat** gives you the possibility to programm schedule **ONLY** by SALUS Smart Home app. You can choose from 3 different schedule configurations:

- Separate schedule for working days (Mo-Fri) and weekend (Sat-Sun)
- Individual schedules for each day each the week
- One schedule for whole week

To activate schedule mode:

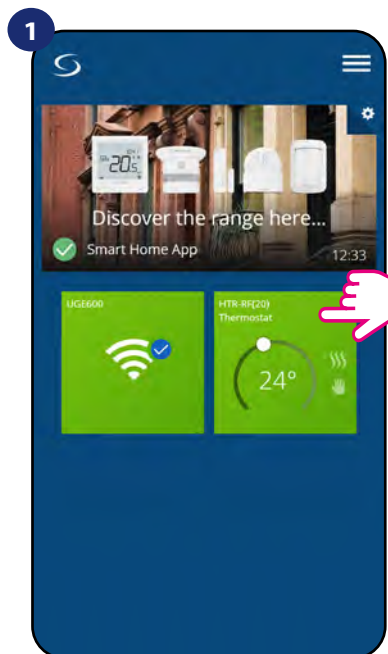

Select thermostat in the main app menu.

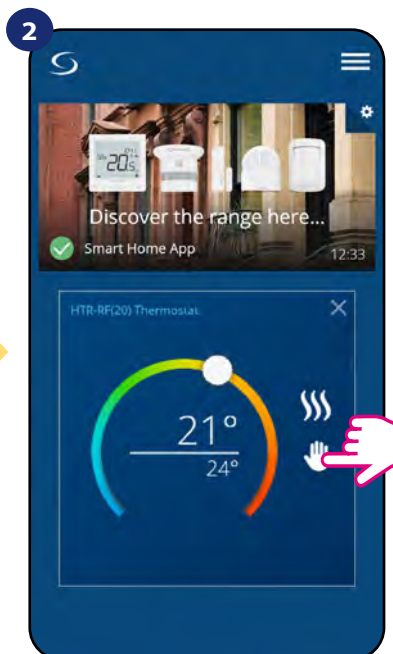

Click on the work mode icon.

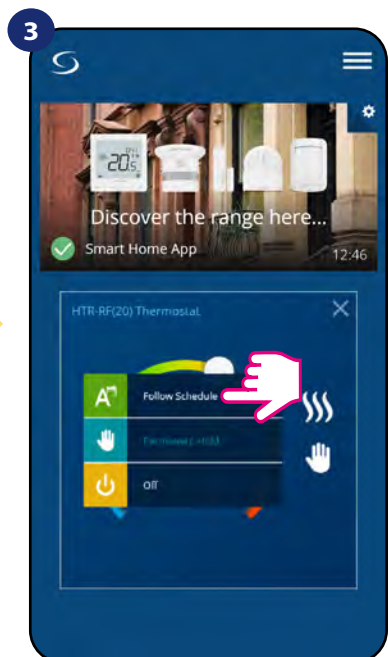

Choose „Follow Schedule” work mode.

Additionally, you can choose to set the Default schedule that already exist in the App, or to modify it according to your preferences. The schedule is displayed at the bottom of screen of your App on the selected thermostat. You can activate the schedule by pressing the Follow Schedule icon on your App.

TO SET THE SCHEDULE IN THE APP:

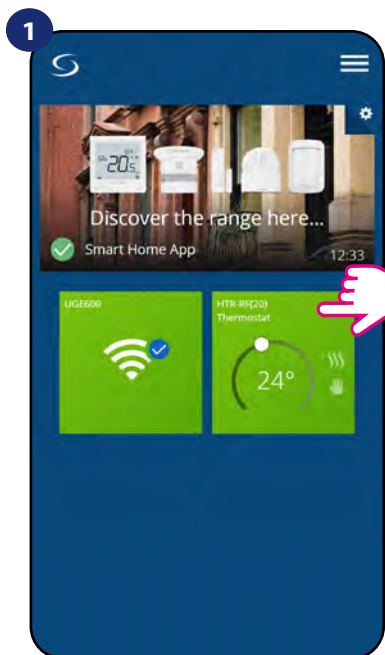

1 Select thermostat in the main app menu.

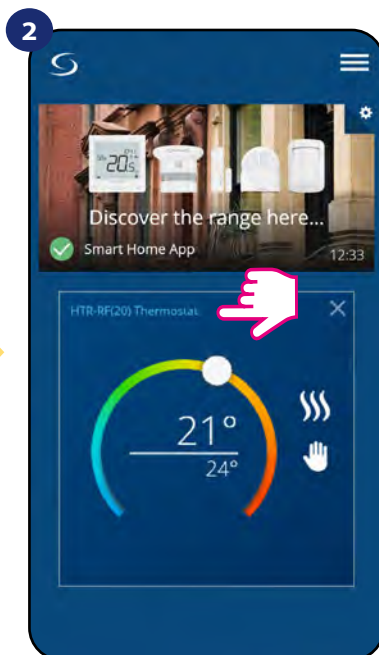

2 Press thermostat's name.

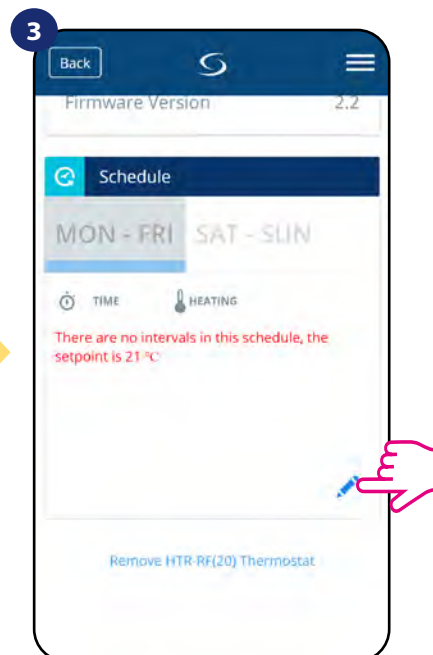

3 Scroll down and press pencil button.

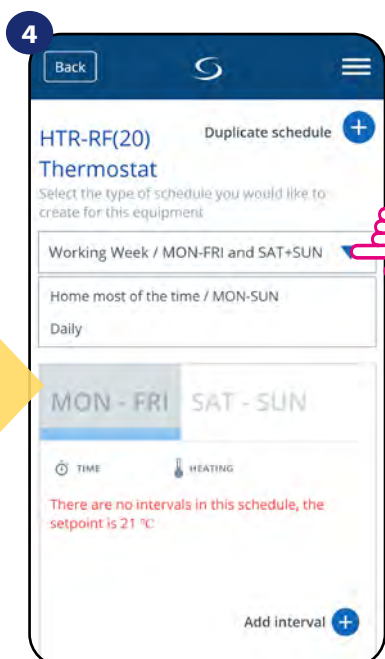

4 Choose for which days you want to program your schedule:

- Working Week / MON - FRI and SAT + SUN
- Home most of the time / MON - SUN
- Daily

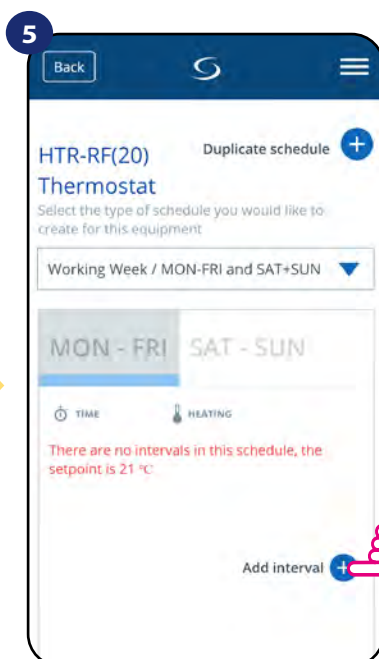

5 After days period selection use „Add interval” option to add your intervals to the schedule.

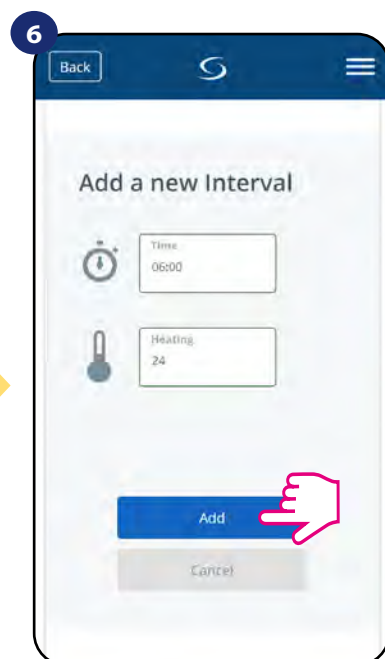

6 Then add a start time and temperature setpoint, after all - confirm by pressing „Add” button.

Please note:

You can add **as many intervals as you wish** by repeating the procedure described from **steps 3 to 6**. The procedure is the same for all 3 schedule configurations. You can customize the programs on the thermostat in any way you want.

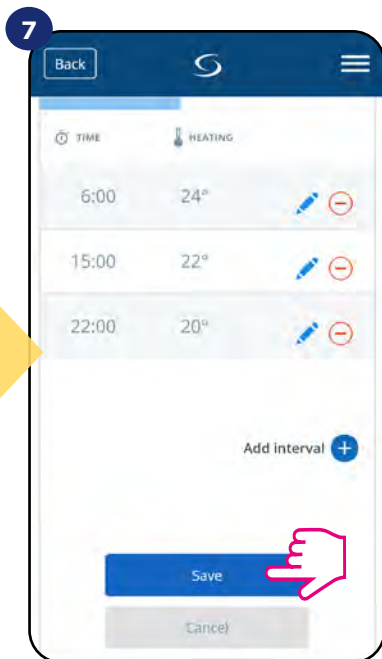

After you've added all the intervals, tap „Save” to save it. Your schedule has been saved and set.

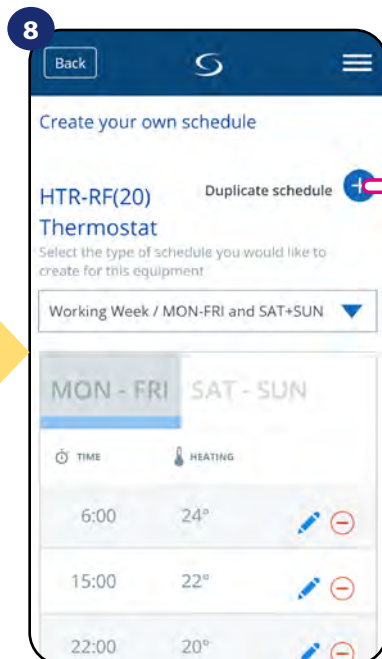

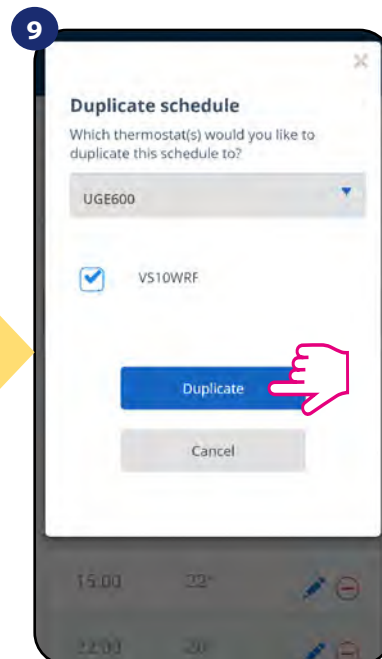

ADDITIONALLY: You can duplicate the same schedule for other thermostat's. Click on the „Duplicate schedule” option.

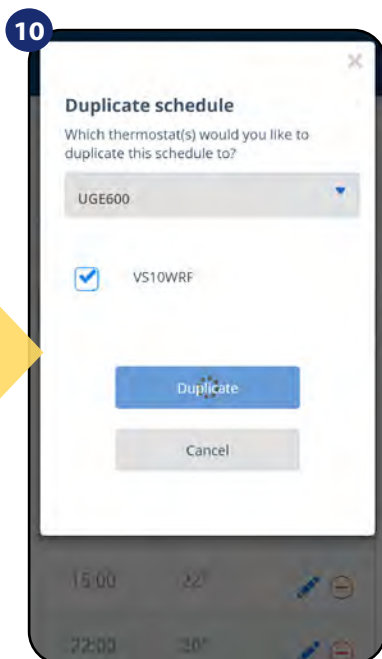

Select thermostat for which you want to duplicate the schedule.



Now app is saving your choice and after it you will have the same schedule for thermostat's you've selected.

 **PLEASE NOTE:** To delete any interval in the schedule just use  button next to selected interval.

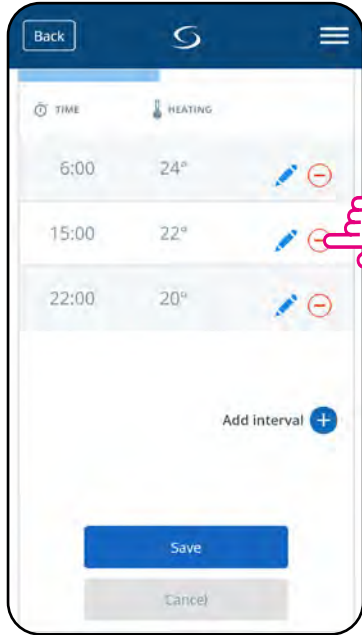

 **Please note:**

When thermostat has no schedule (or it has been deleted) then it maintains a constant temperature 21 °C (in „Follow Schedule” mode).

TO SET DEFAULT SCHEDULE:

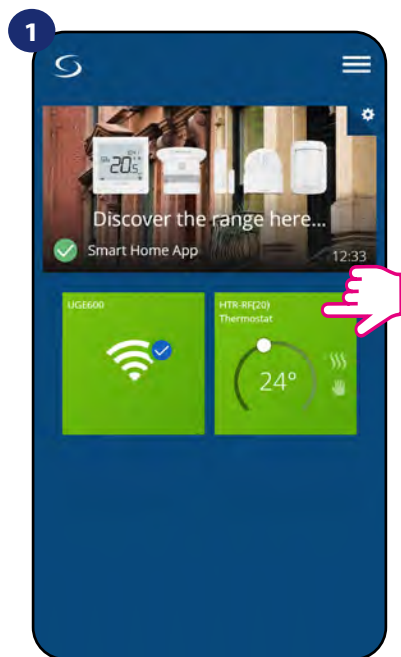

Select thermostat in the main app menu.

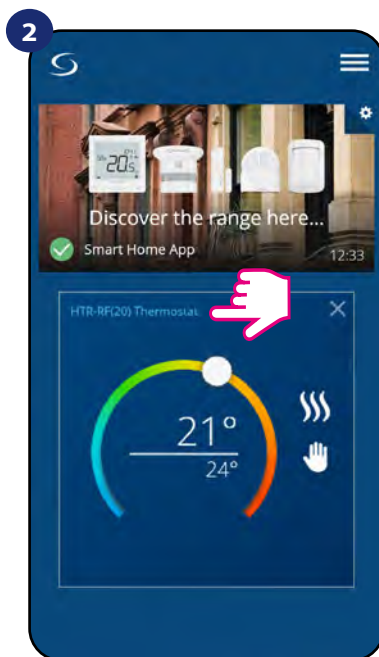

Press thermostat's name.

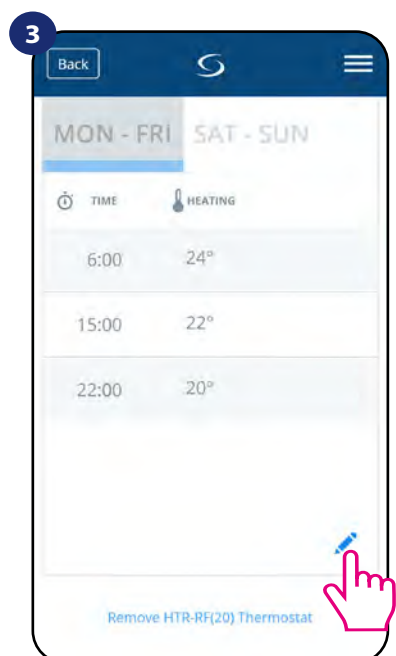

Scroll down and press pencil icon.

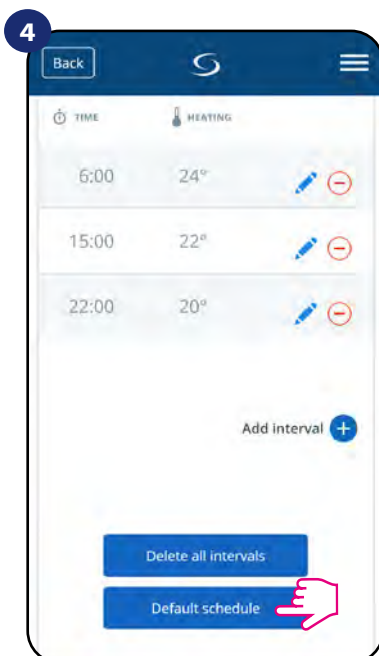

To set default schedule use „Default schedule“ button. It will remove all current intervals and it will set default schedule.

6.6.2 Temporary override mode

Temporary override mode means manual temperature change during active schedule mode:

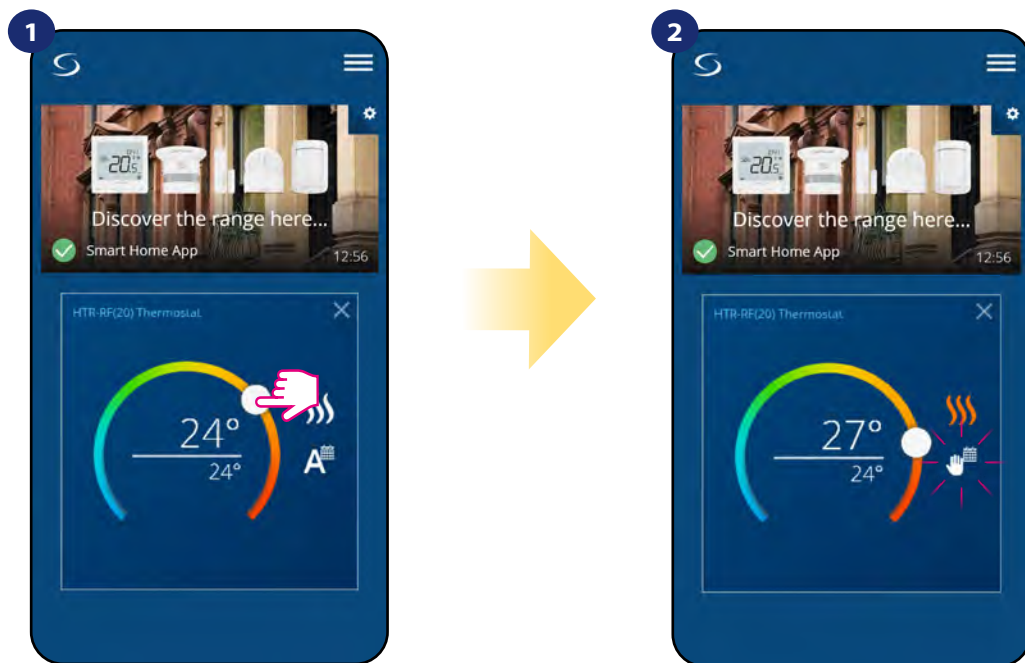

When „Follow schedule” mode is active, use slider to set new setpoint temperature.

When you have overwritten the temperature then hand icon will appear next to calendar which means that temporary override mode is working until next schedule program.

 **NOTE:** Temporary override mode will be maintained until next program will come, as it has been set in the schedule.

6.6.3 Manual mode

If the thermostat follows a schedule or is in frost protection mode, user can change the operating mode to the **manual mode**. In **manual mode** thermostat will maintain setpoint temperature until user will manually change it to a new value or select a new operating mode. When thermostat works in **manual mode**, the hand icon  will be displayed in the app screen.

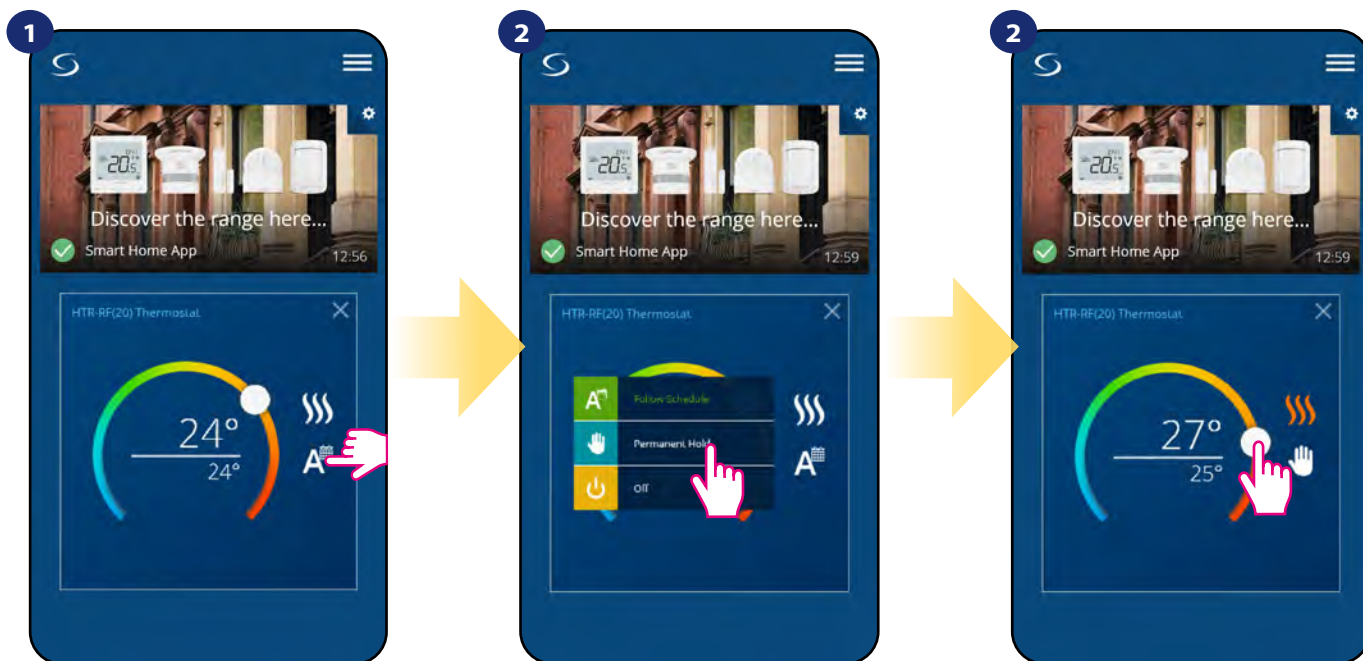

Click thermostat's work modes icon.

Select „Permanent Hold” mode.

Hand icon confirms that thermostat is in manual mode.

6.6.4 Frost protection

In **Frost protection mode** the thermostat is displaying actual room temperature and maintain „frost protection” setpoint temperature. When thermostat works in **Frost protection mode** then you have no possibilities to change temperature setpoint. To activate **Frost protection mode** online please follow steps below:

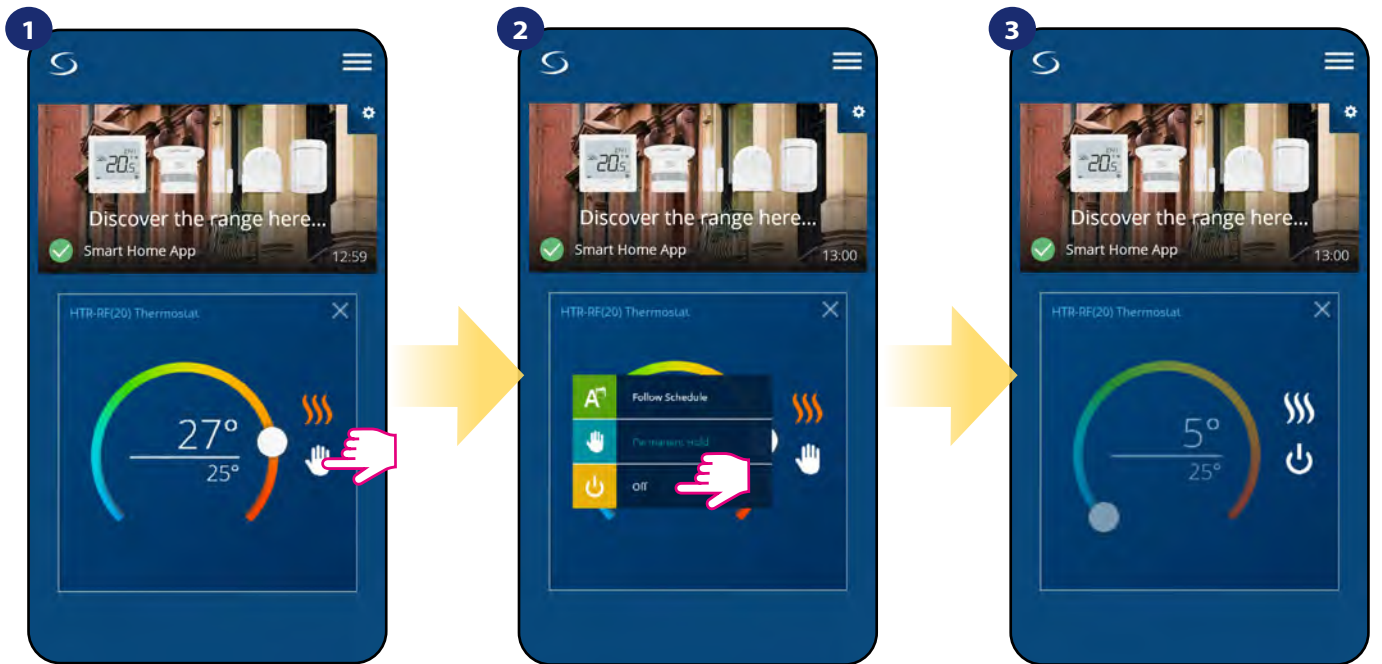

Press thermostat's work modes icon.

Select „OFF” mode.

Thermostat is in frost protection mode.



NOTE: When the thermostat exits frost protection mode, previous mode will be restored.

6.7 Compatibility with window/door sensor OS600 / SW600

HTR-RF(20) thermostat paired with window/door sensor **OS600/SW600** allows to create OneTouch Rules when window/door is **opened** or **closed**. If thermostat will receive information from window/door sensor (that window has been opened for example) then OneTouch rule will turn off heating until window close. If you want to have access to this function then first you have to add window/door sensor **OS600** or **SW600** (please refer to the **OS600** or **SW600** manual instruction).



To pair window/door sensor OS600/SW600 with HTR-RF(20) thermostat please follow steps below:

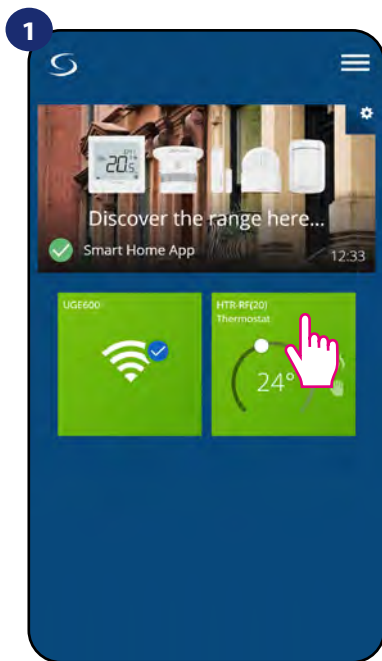

Select the thermostat in the main app menu.

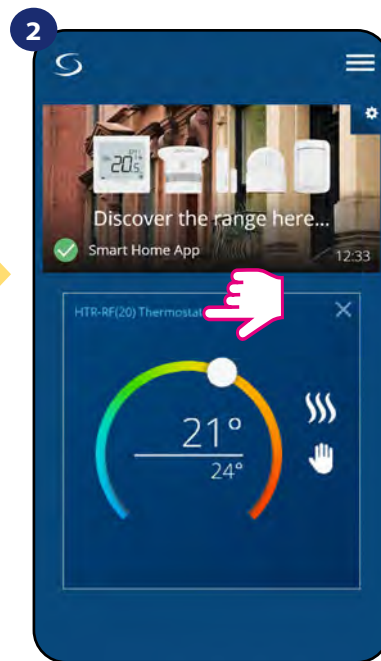

Press thermostat's name.

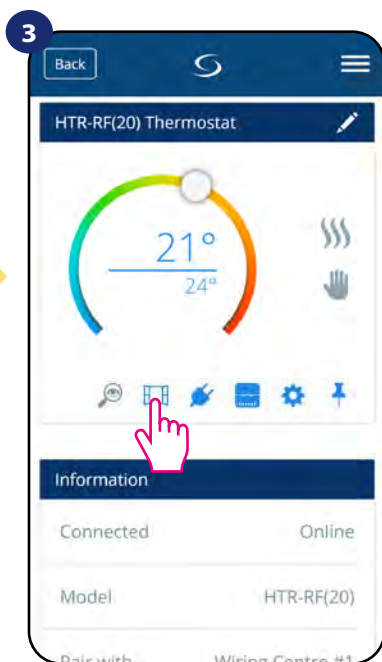

Choose the window icon.

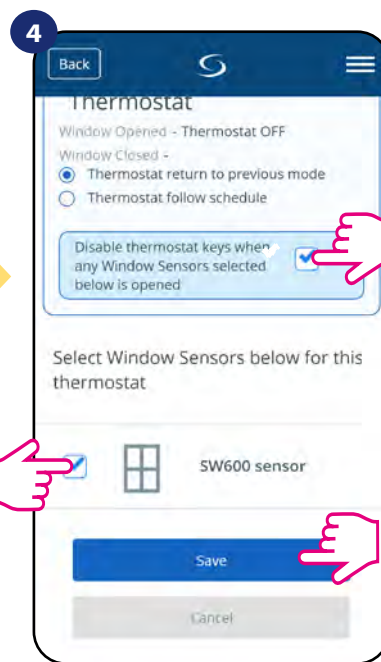

Mark sensors which you want to link together with the thermostat. You can additionally lock buttons on thermostat when window is opened by marking option above. Press „Save” button to finish pair process...

6.8 Compatibility with Smart Plug SPE600

HTR-RF(20) thermostat paired with **SPE600 Smart Plug** allows to turn on/off any electric device eg. pump, radiator or valve with actuator. When thermostat starts heating then plug will **turn on** device (or **turn off** when there is no need to heat). If you want to have access to this function then first you have to add **SPE600 Smart Plug** to the **SALUS SmartHome system** (please refer to the **SPE600 manual instruction**).



To pair SPE600 Smart Plug with HTR-RF(20) thermostat please follow steps below:

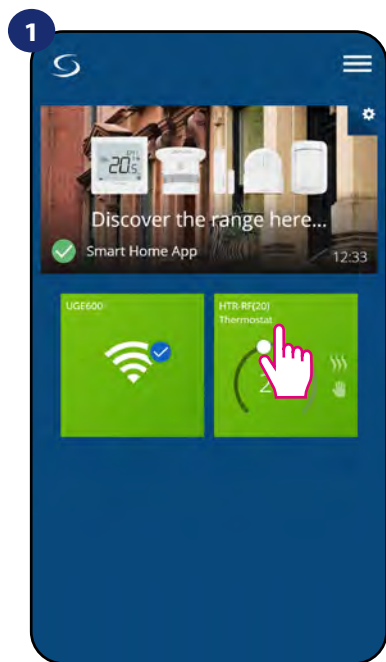

Select the thermostat in the main app menu.

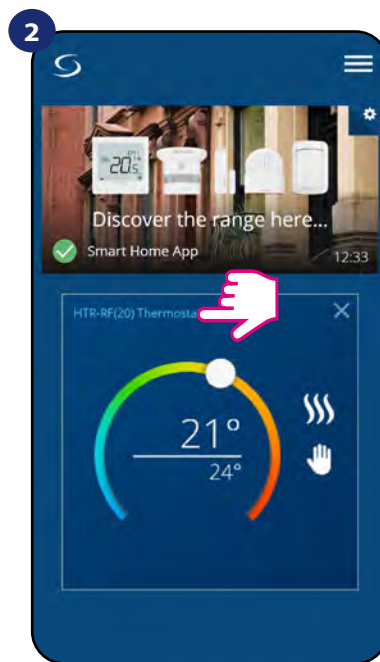

Press thermostat's name.

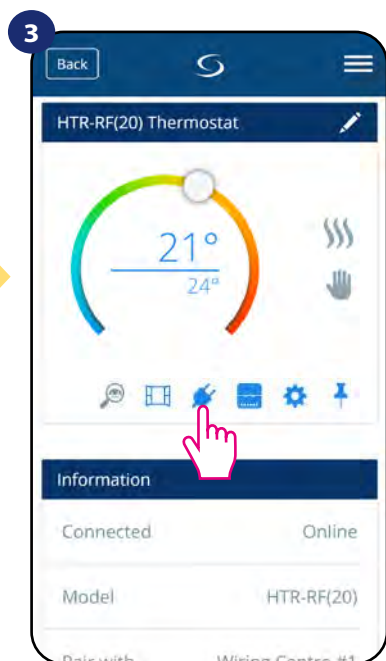

Choose the plug icon.

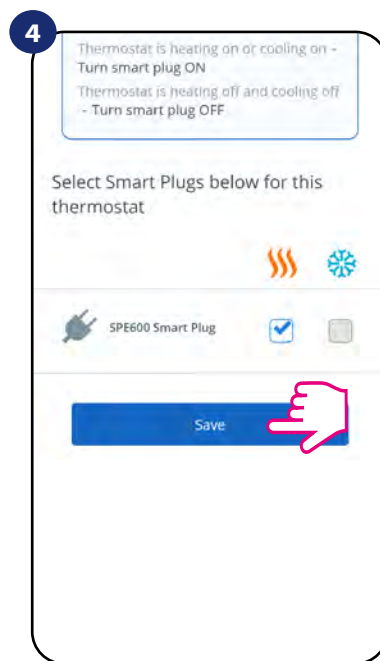

Choose plugs which you want to add to the thermostat. Press „Save” button to finish pair process...

6.9 Compatibility with Smart Relay SR600

HTR-RF(20) thermostat paired with **Smart Relay SR600** allows to wireless control of eg. radiator, pump, boiler. When thermostat start heating then **SR600 Smart Relay** will **turn on** device (or **turn off** when there is no need to heat). If you want to have acces to this function then first you have to add **SR600 Smart Relay** to the **SALUS SmartHome** system (**please refer to the SR600 manual instruction**).



To pair SR600 Smart Relay with HTR-RF(20) thermostat please follow steps below:

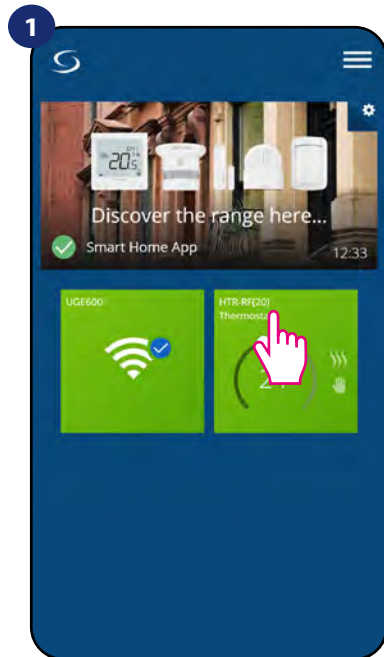

Select the thermostat in the main app menu.

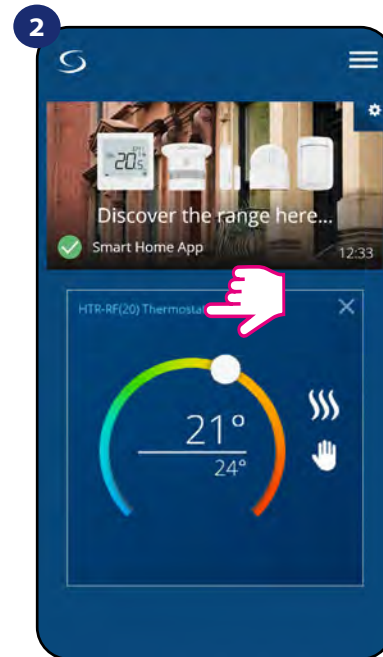

Press thermostat's name.

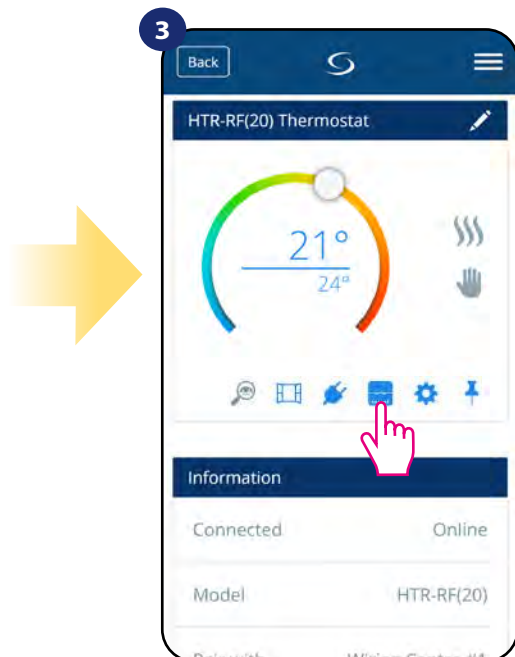

Press the relay icon.

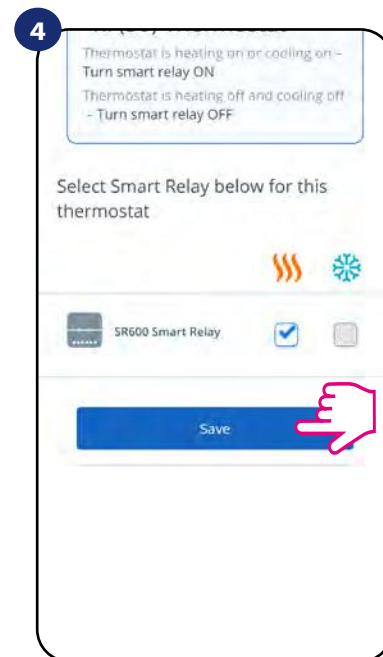

Choose SR600 relays which you want to add to the thermostat. Press „Save” button to finish pair process...

6.10 Identification mode

Identification mode can be useful when we are pairing more than one device in one moment and we don't know which device is which. Beyond, if our system include more that one **UGE600 Universal Gateway** then we can easily identify which device is paired with which gateway.

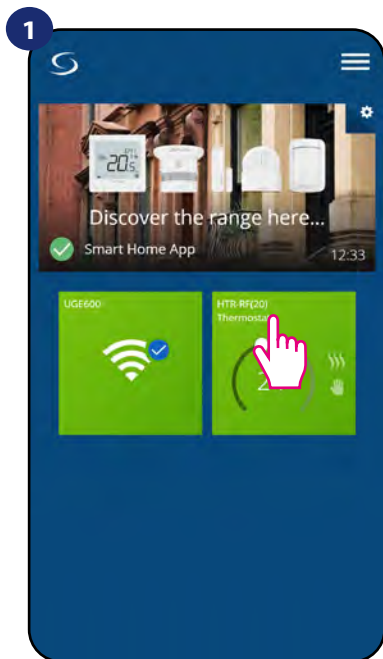

Select the thermostat in the main app menu.

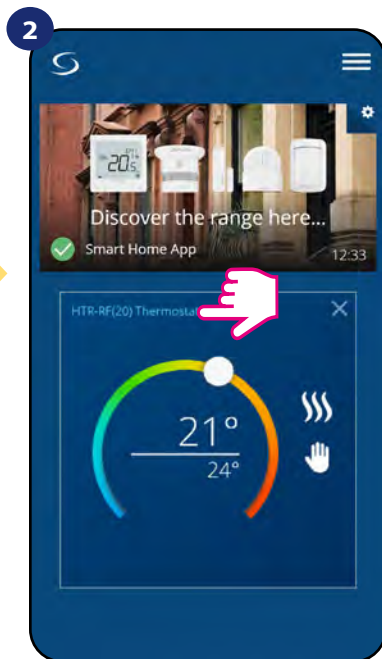

Press thermostat's name.

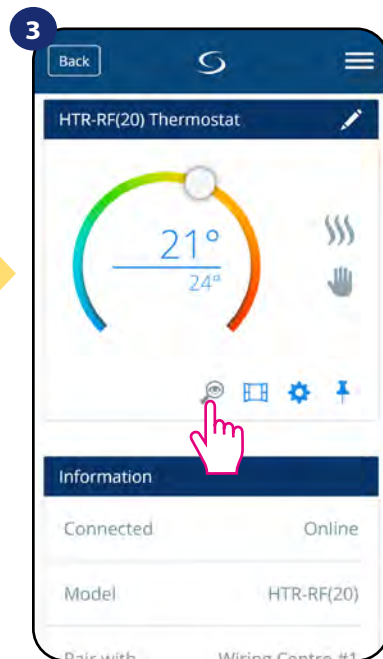

Use the magnifying glass icon.

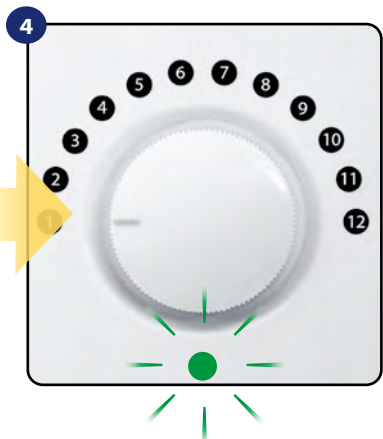

In the **Identification mode** thermostat's green diode will start blinking.

You can also identify your device during thermostat's pairing process:

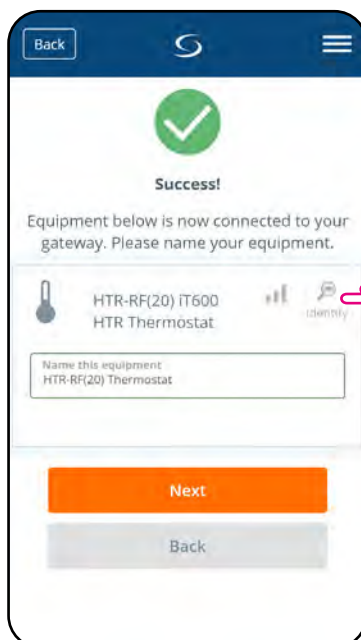

Click on the magnifying glass icon.

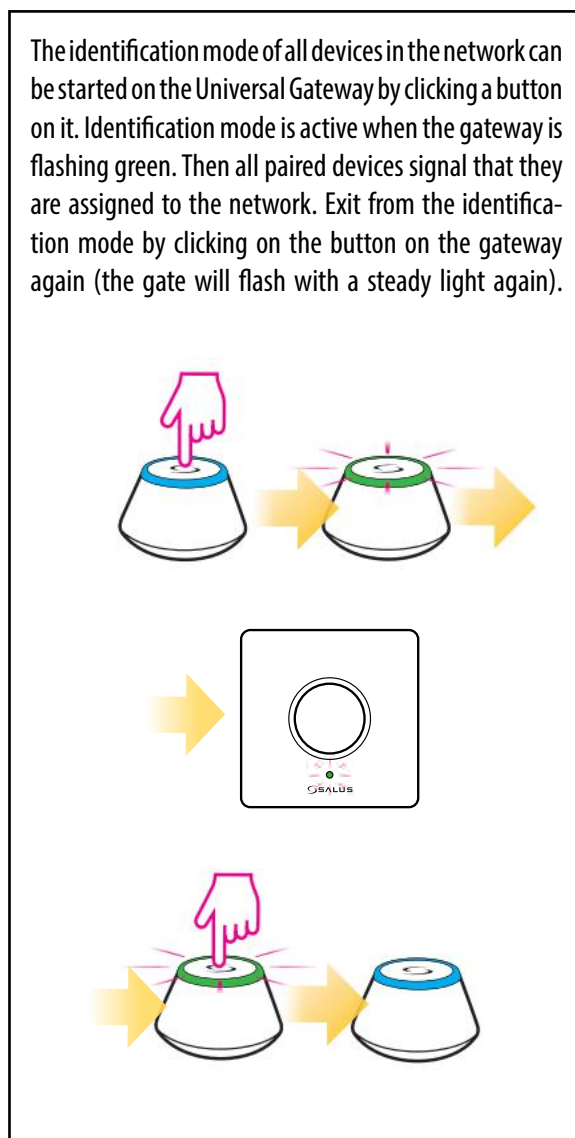
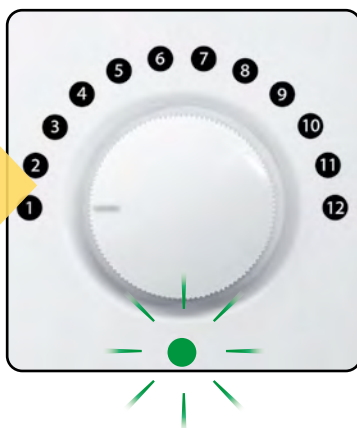

6.11 Pinning/unpinning thermostat to/from application dashboard

To pin/unpin thermostat from dashboard in Smart Home application please follow steps below:

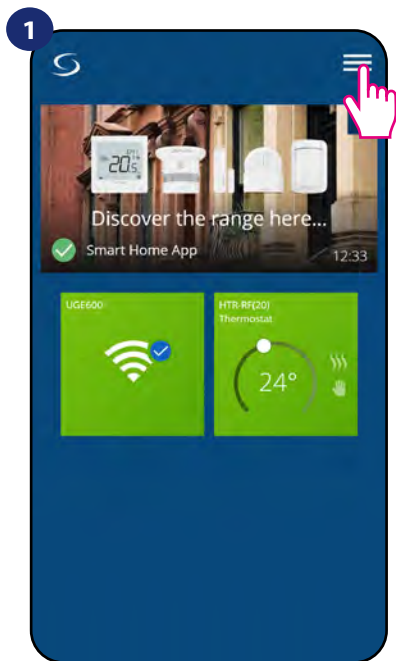

Open main menu in the app.

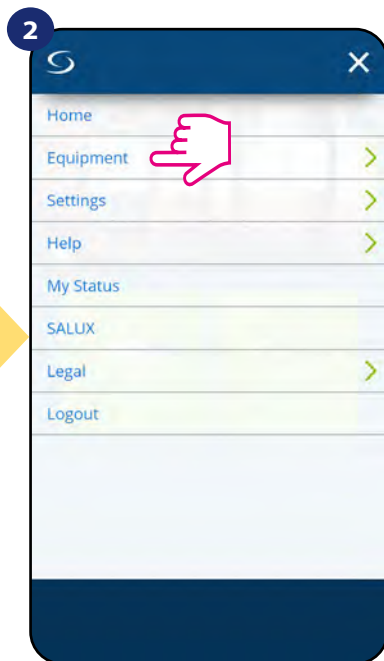

Select equipment.

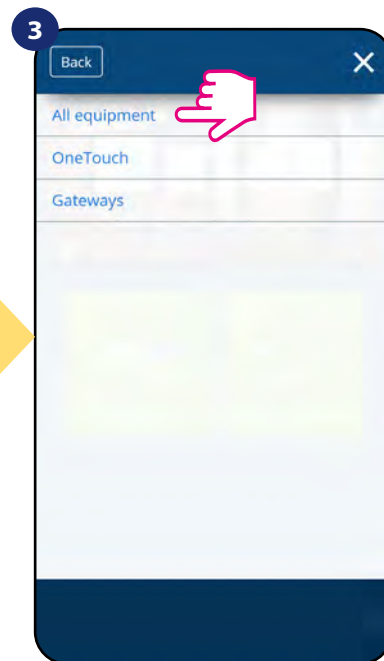

Select All equipment option.

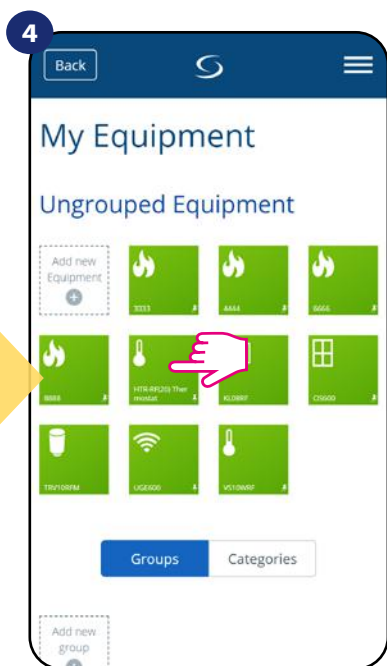

Select your HTR-RF(20) thermostat.

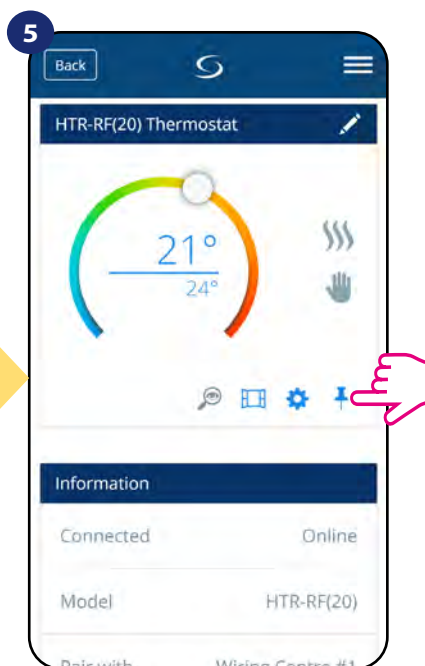

Press on the „Pin“ icon to pin/unpin thermostat to/from the app dashboard.

6.12 User settings (basic settings)

User settings of HTR-RF(20) thermostat determine basic thermostat parameters. Please see below how to enter those settings:

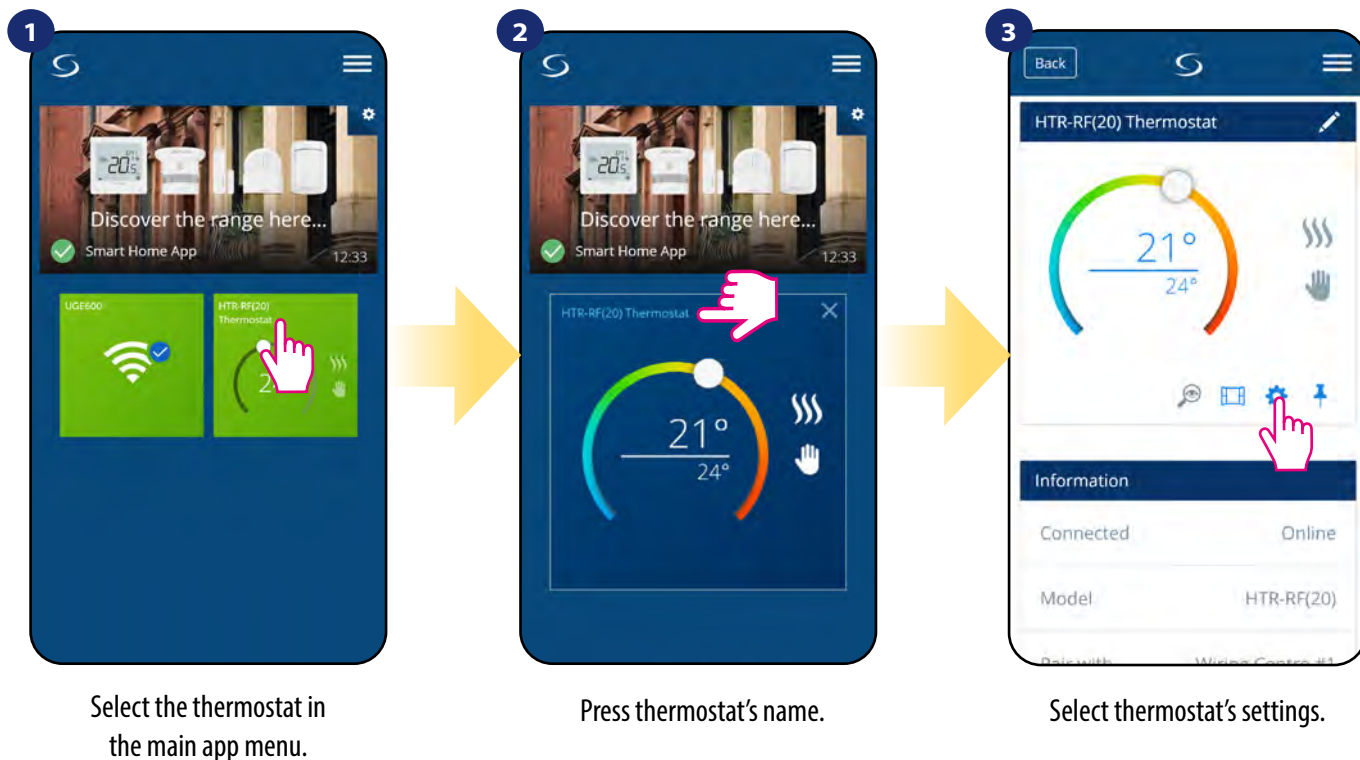

4
Scroll down to the settings section.

BASIC SETTINGS:

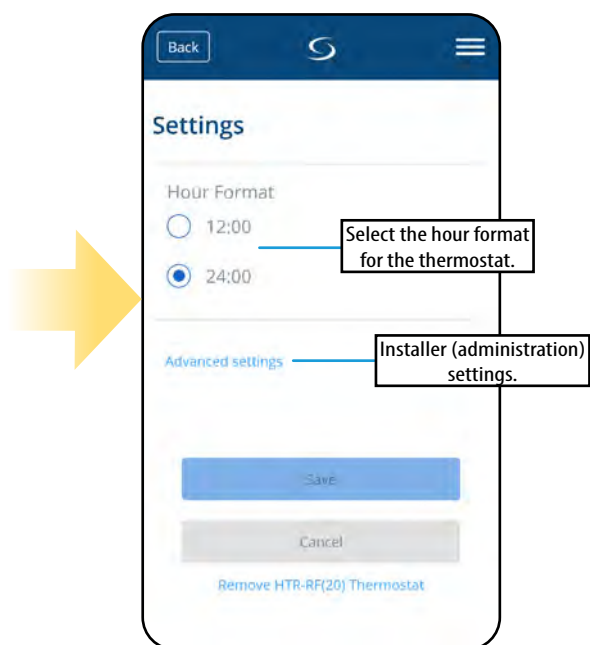

6.13 Admin settings (installer parameters)



PLEASE NOTE: Admin settings are mainly for qualified installers or knowledgeable users.

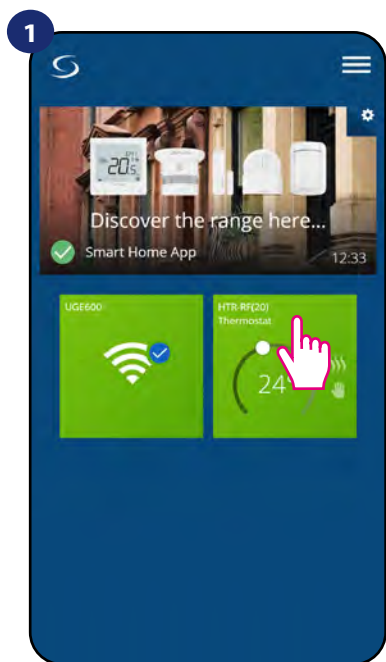

Select the thermostat in the main app menu.

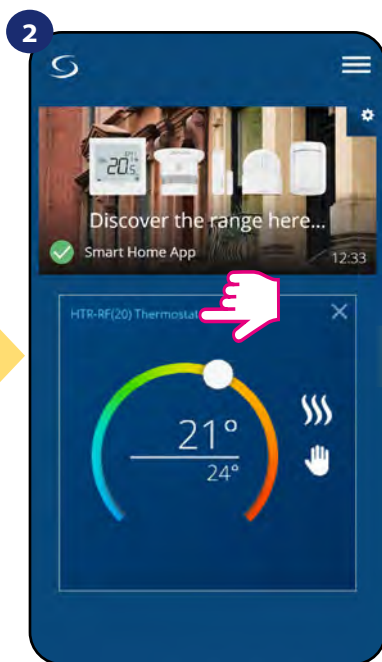

Press thermostat's name.

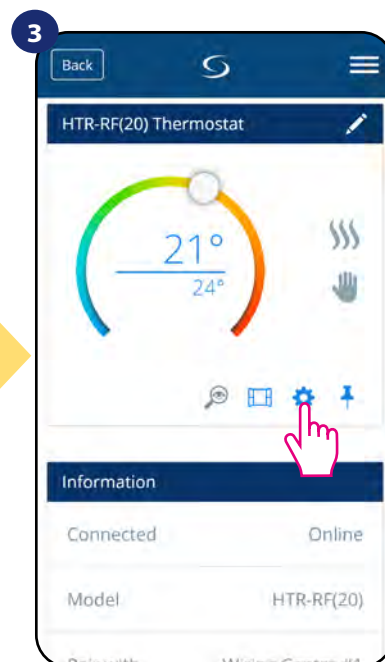

Select thermostat's settings.

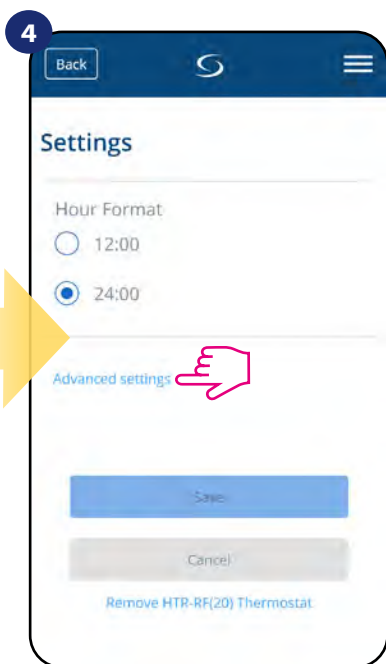

Scroll down to enter „Admin settings“.

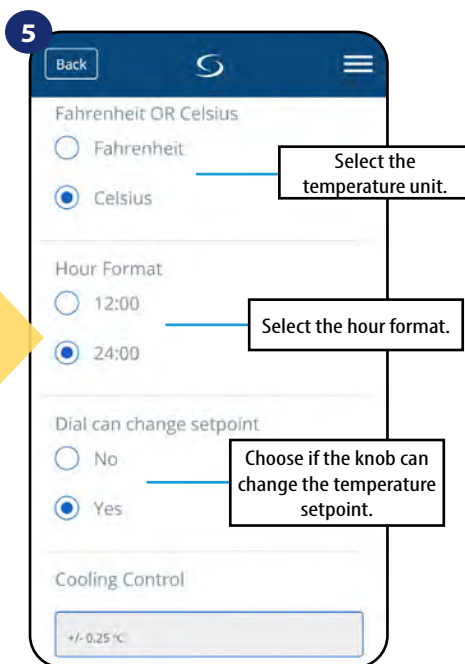

6.14 OneTouch rules (add/edit)

OneTouch - function that distinguish **SALUS Smart Home system** in terms of functionality. **OneTouch** rules are pre-configured set of actions defined in the interface easy in use. You can **switch it on or off** anytime. **OneTouch** informs thermostat or other device how it has to work according to pre-set settings. In application are **4 pre-defined OneTouch** rules:

- **Party Mode** - set thermostat temperature to 21 °C for 2 hours
- **Comfort Temperature** - set thermostat temperature to 21°C
- **Frost Protection Mode** - set thermostat to the Frost Mode (temperature setpoint can be set in the user settings) - 5°C by default
- **Holiday Mode** - set thermostat to the Holiday Mode



To activate **OneTouch** rules please follow steps below (example on **Party Mode**):

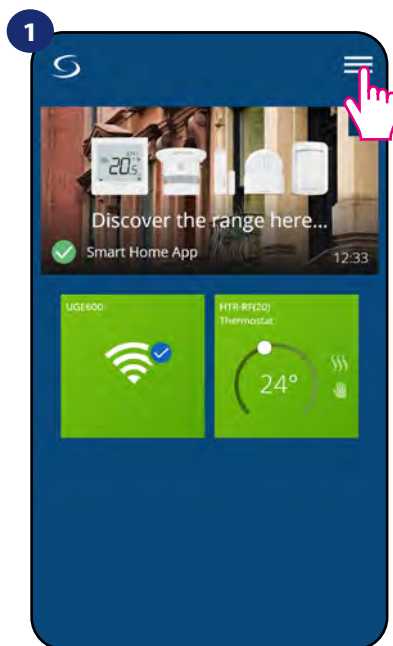

Open main menu in the app.

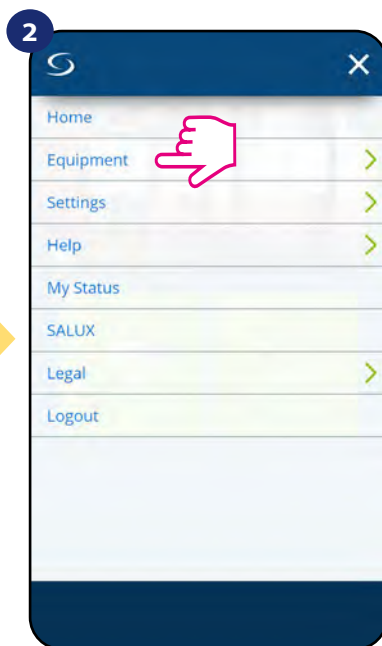

Select equipment.

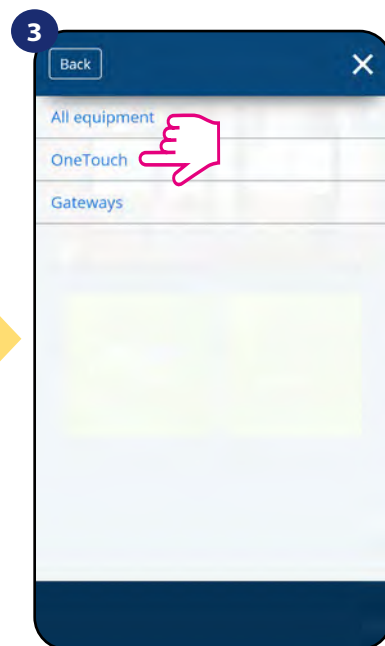

Select OneTouch option.

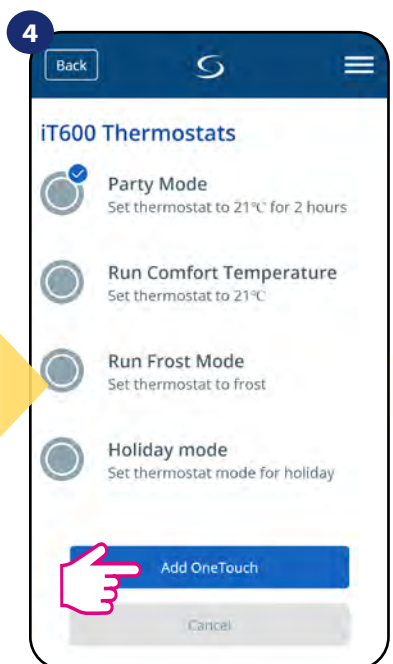

Choose „Party Mode” as a one of the built-in OneTouch rules. Click „Add OneTouch” to add it.

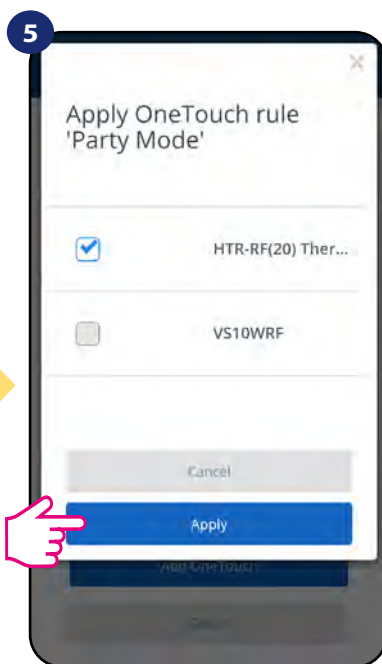

Select thermostats which you want to configure with this rule. Press „Apply” to confirm.

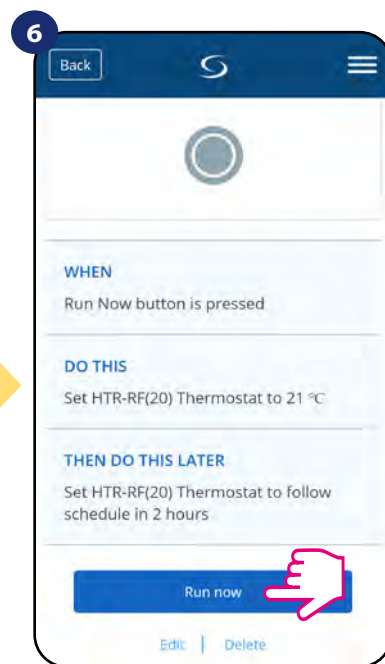

Party Mode has been activated. You can check how it works by pressing „Run now” button.

You can also create your own **OneTouch** rule. As an example we will create OneTouch rule which activates „send me a notification” action under „temperature is below 10 °C” condition. Please look at the steps below how to set this **OneTouch** rule.

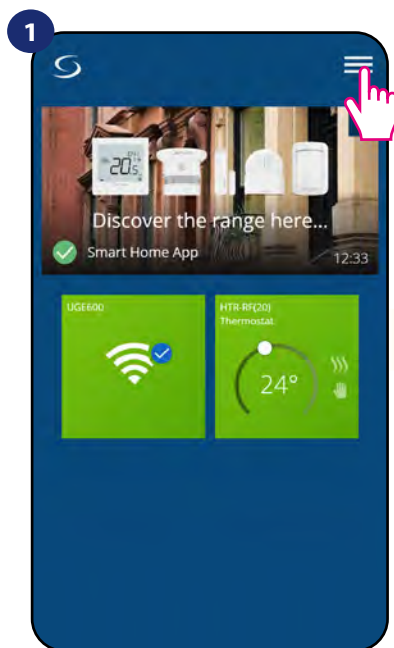

Open main menu in the app.

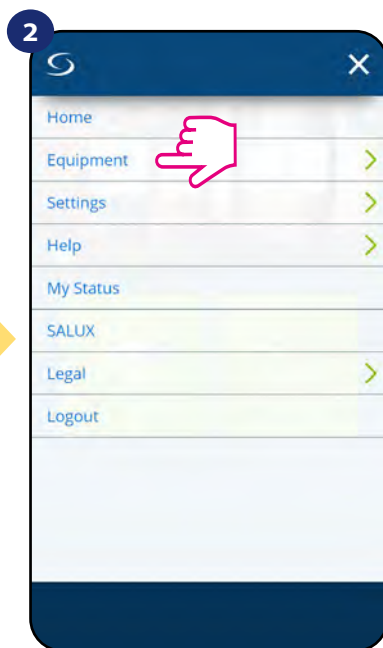

Select equipment.

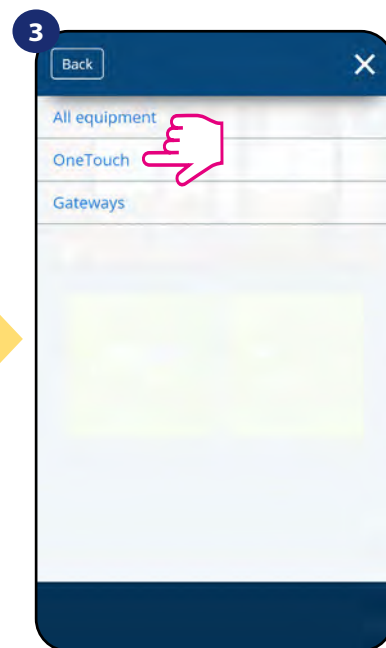

Select OneTouch option.

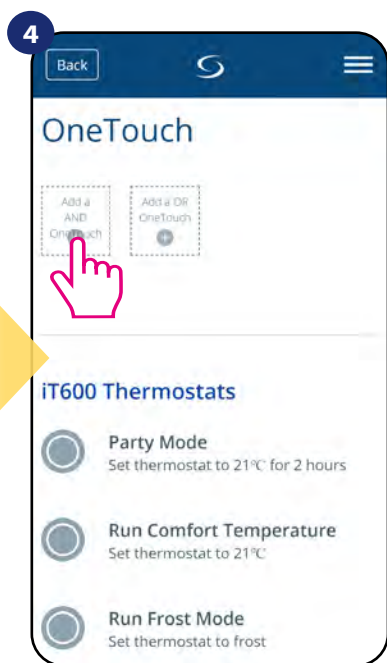

Press „Add a AND OneTouch” button.

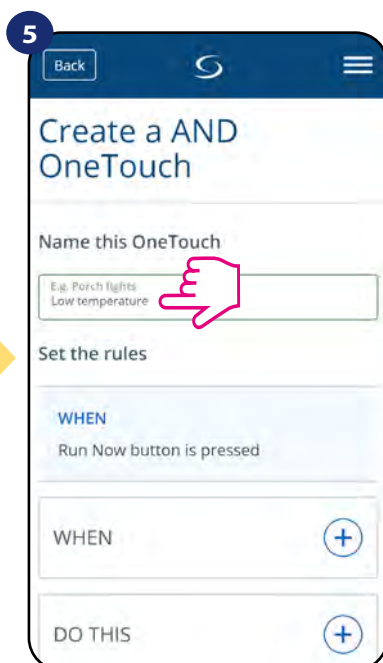

Enter OneTouch rule name.

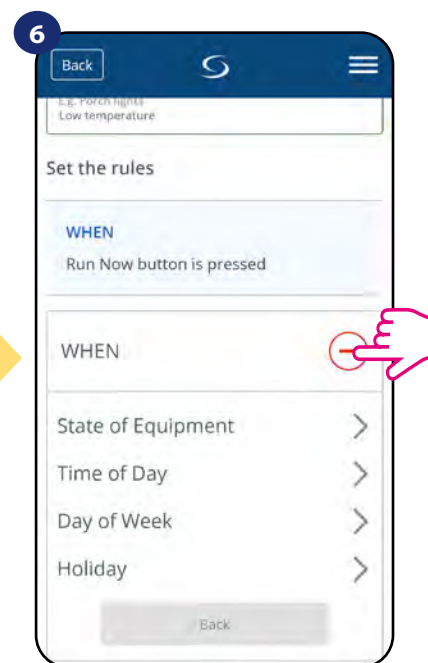

At this step choose condition which have to be fulfill in order to activate the rule.

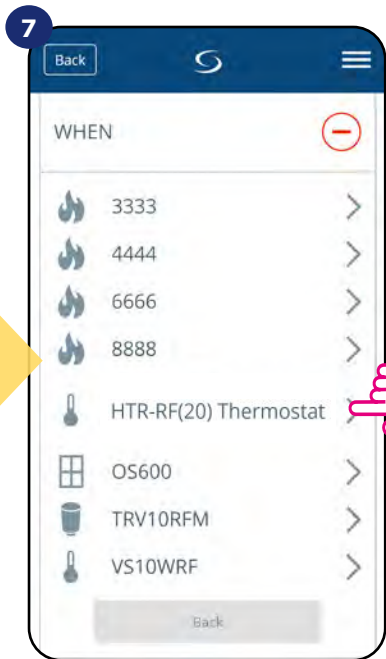

Select which thermostat you want to link up with your OneTouch rule.

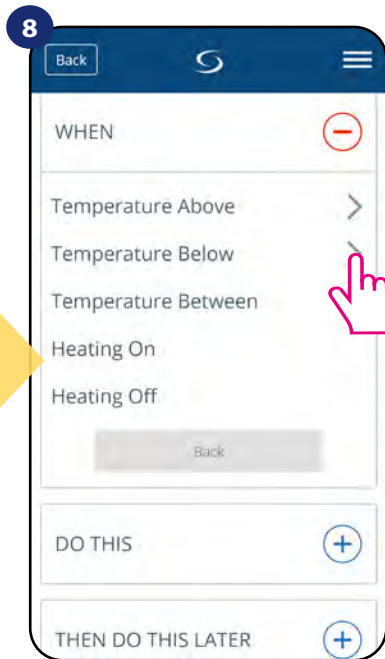

Choose the condition details for your thermostat. In this case select „Temperature Below” option.

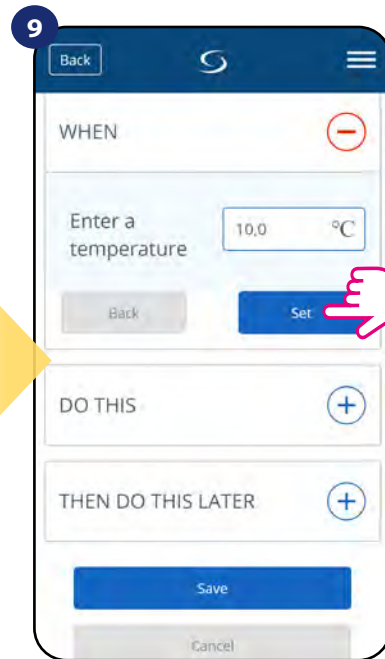

Enter a temperature setpoint trigger for your OneTouch rule. Press „Set” button to confirm.

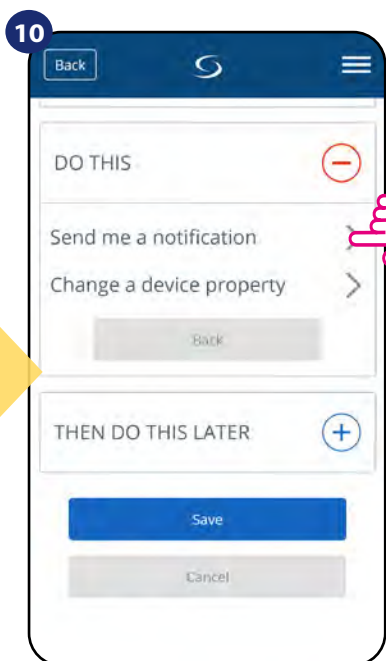

Select „DO THIS” option to create OneTouch rule action.

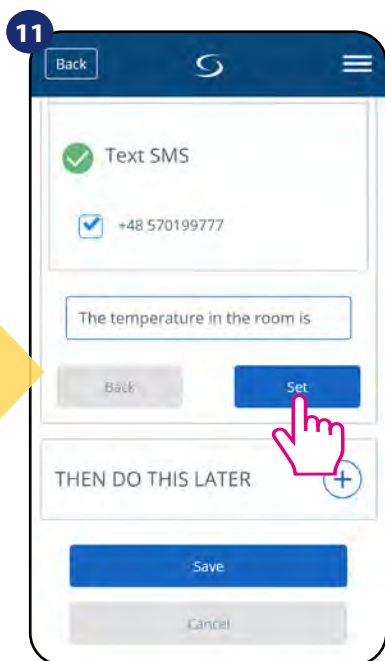

Choose e-mail or SMS notification and enter the message content. Confirm by pressing „Set” button.

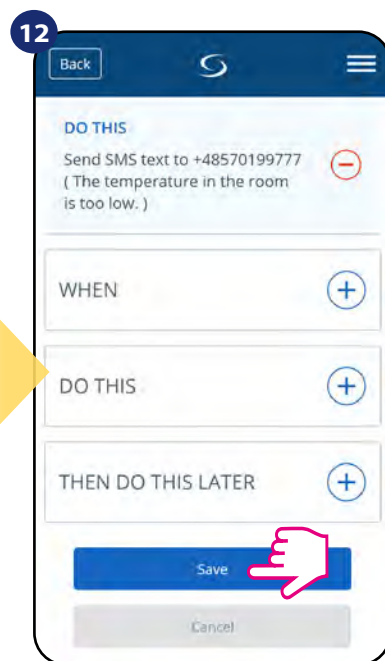

To finish OneTouch rule creation press „Save” button.

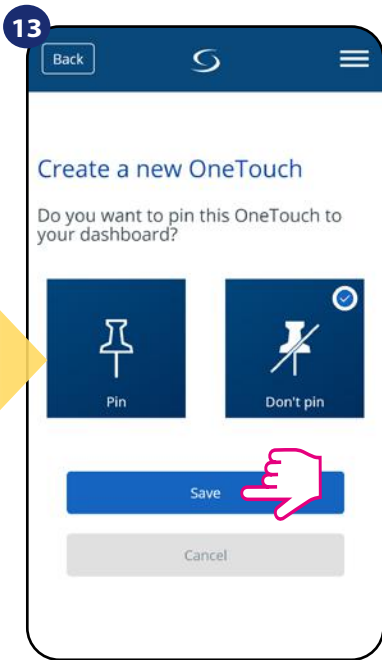

As an option OneTouch rule tile can be pinned to the dashboard.

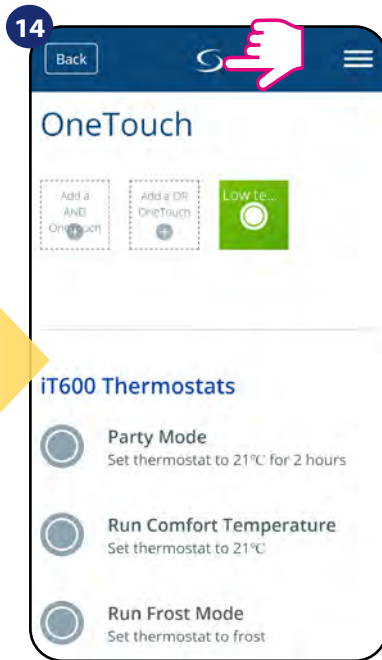

Newly created OneTouch rule tile can be found under OneTouch main menu...

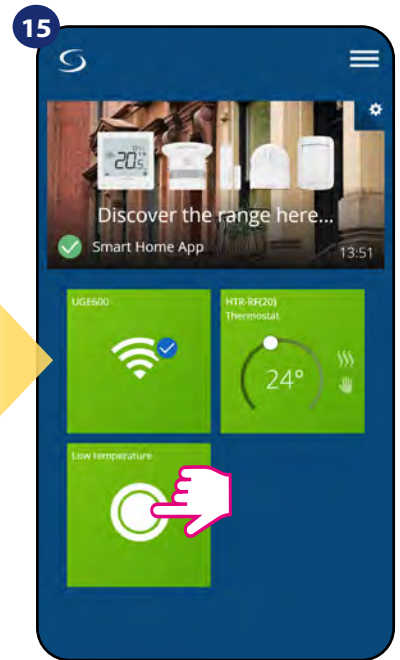

... and on your dashboard.

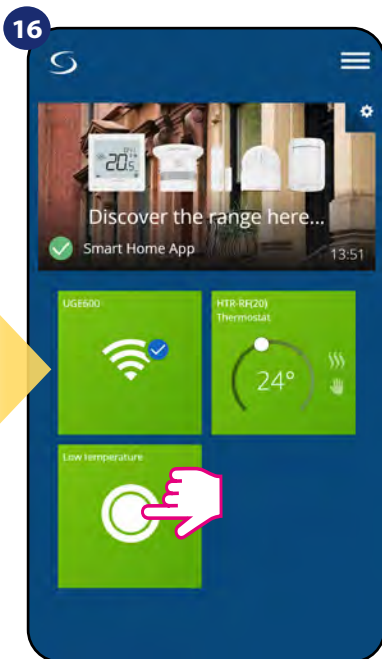

To force OneTouch rule activation select it tile...

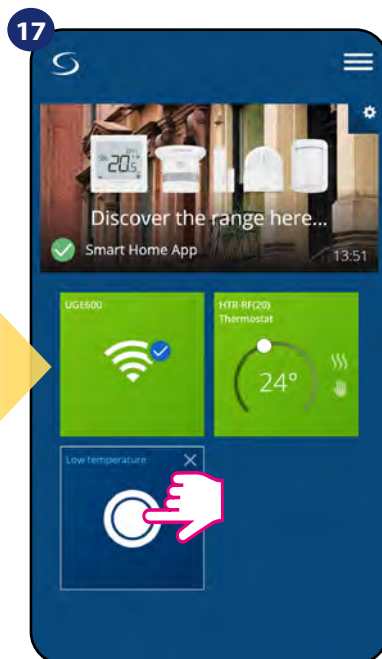

...and press it's button.

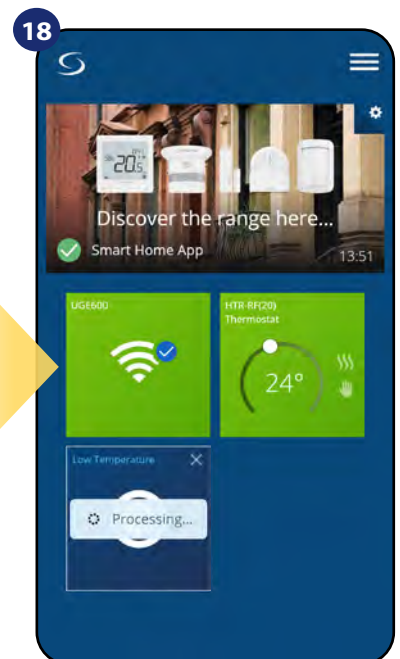

OneTouch rule is now activated. In this example SMS message will be send to the user.



Please note: SMS notifications will be send to the user **only** if they are activated in the OneTouch settings and UGE600 Universal Gateway is connected to the Internet.

6.15 Error codes (exclamation mark in app)

If there is any error in the Smart Home system which relates to the devices performance or functionality then the Smart Home app will inform user about it by a red exclamation mark in the upper menu. Please look at the example below:

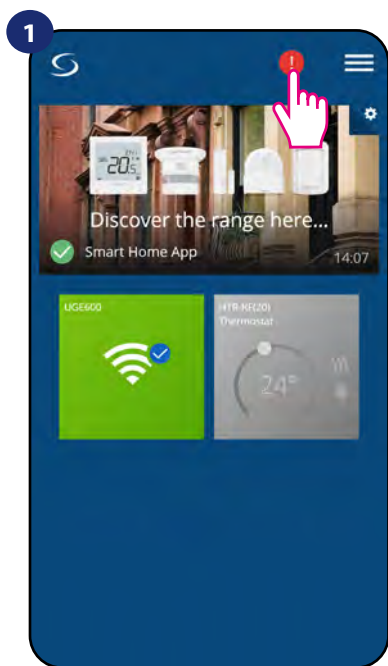

Press the exclamation mark button.

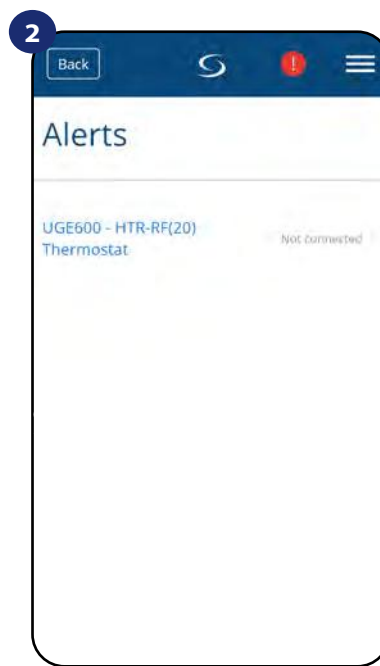

All current errors are displayed.

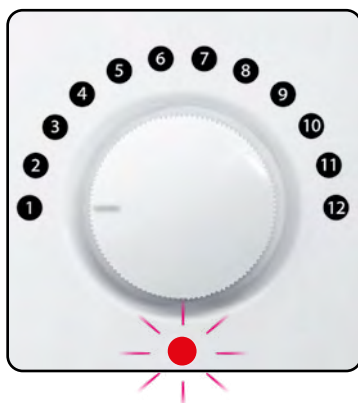

Main errors are also reported by thermostat's LED diode. Please see below diode sequence descriptions:

LED diode	Description
● ● ● ● ● ● ...	Lost connection with CO10RF, KL08RF, UGE600 (red LED flashing)
● ● ● ● ● ● ...	Low battery (fast flashing 3 times every 10 seconds)
● ● ● ● ● ● ...	Error when installing the thermostat - signaling of an occupied zone in the wiring centre by another thermostat or adding to a non-existent wiring centre in the network (alternating red and green diodes blinking)
—	Signaling of the restoration of factory settings after a longer pressing of the SYNC button (the orange diode will light for a second)



When problem has been solved - exclamation mark will disappear in application and thermostat will stop flashing error.

6.16 Wireless signal strength test

Each wireless device has a limited range. Beyond distance there are many more elements which could affect on. For example - concrete walls, other wireless network interferences, wooden walls, reinforced concrete ceilings, metal construction elements, pillars, aluminium foil for underfloor heating etc. Smart Home system has built-in function which allows to check wireless signal quality. If you want to check your system connectivity and signal's strength please follow steps below:



Press the gear icon in upper right corner of the background image.

Select „Scan my home” option.

Here you can check wireless signal quality of given devices.

Signal quality is expressed in **decibel units (db)**. Compare your value with scale below:

-50db to 0db - very good quality signal

-75db to -50db - good quality signal

-85db to -75db - low quality signal

-95db to -85db - bad quality signal, makes wireless connection nearly impossible

 **PLEASE NOTE:** Every Smart Home system device which is powered 230VAC is also working as a signal repeater of ZigBee network. If system is based on battery devices there could be a need to use repeaters like Salus RE600, Salus RE10RF or any other device of Salus Smart Home series which is powered by 230V AC.

6.17 Factory reset (removing thermostat from the app and ZigBee network)

To make thermostat factory reset and remove it from the ZigBee network please follow steps below:

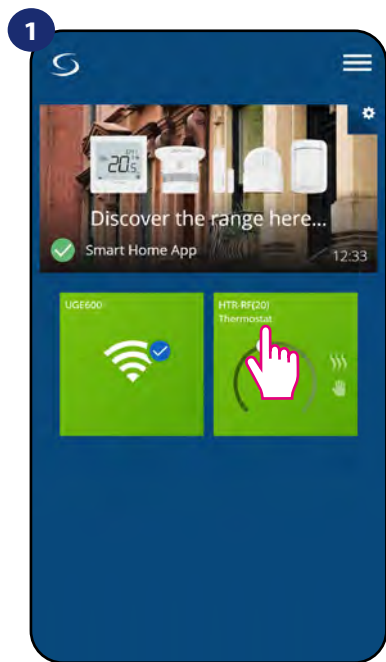

Select the thermostat in the main app menu.

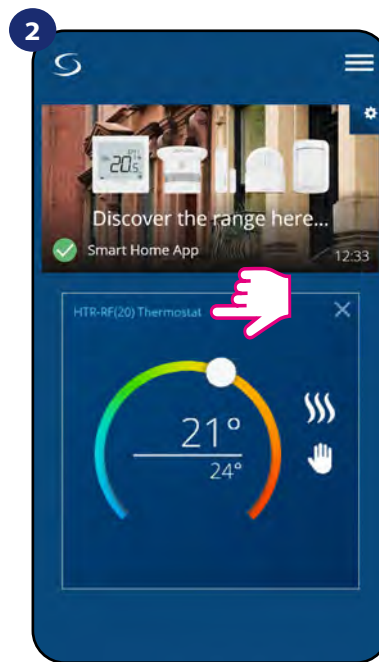

Press thermostat's name.

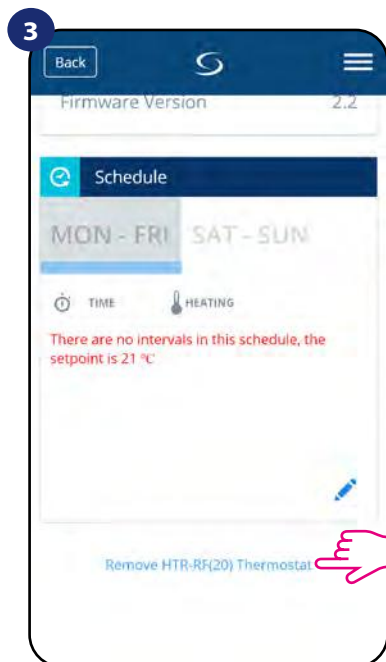

At the very bottom of thermostat's menu choose „Remove” option.

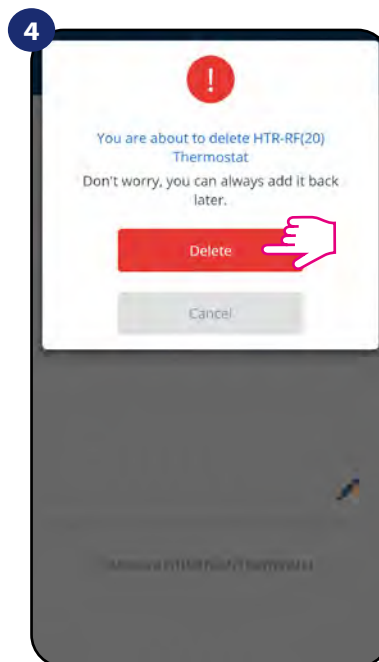

Press „Delete” button to remove your thermostat from the app and confirm factory reset.



NOTE: Factory reset function removes thermostat from the ZigBee network. This means that thermostat is not visible anymore in the „My equipment” list.

You can also do factory reset from the thermostat directly. It will also remove your thermostat from the Zigbee network but you still will be able to see thermostat's tile. After factory reset thermostat tile will change to dark grey colour.

1



Press SYNC button (back of the thermostat) for 5 seconds...

2

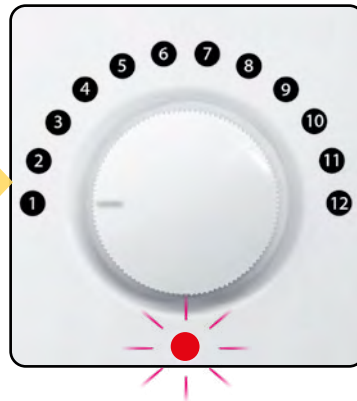

...red diode will start to blink 3 times in a row sequentially.

3

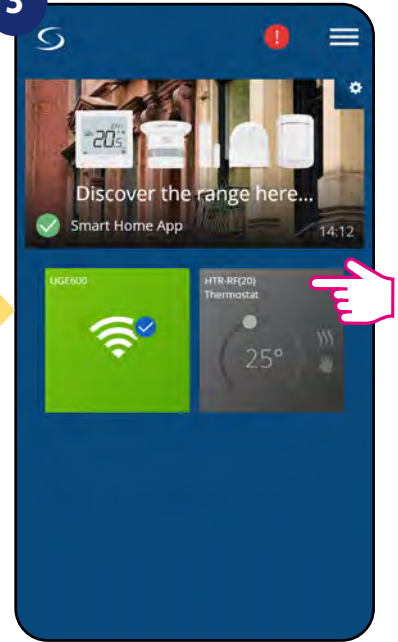

Select the thermostat in the main app menu.

4

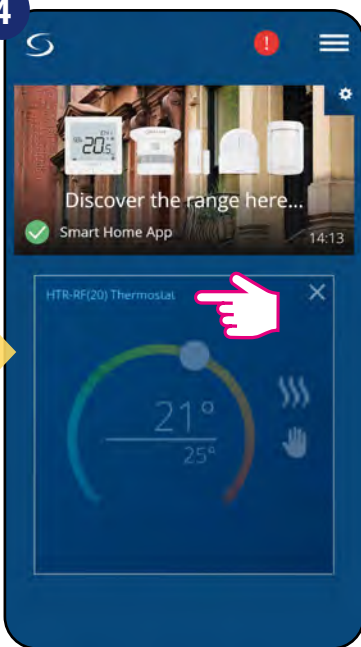

Press thermostat's name.

5

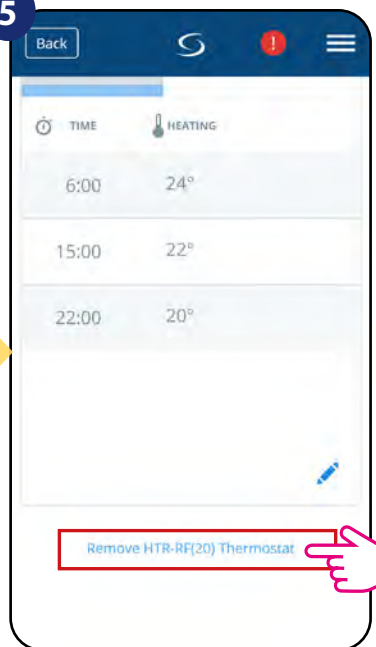

At the very bottom of thermostat's menu choose „Remove” option.

6

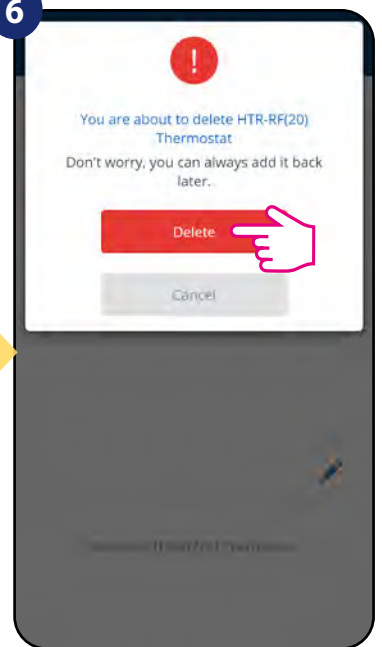

Press „Delete” button to remove your thermostat from the app and confirm factory reset.

7. Installation in OFFLINE MODE without SALUS SmartHome application

7.1 General informations

In **OFFLINE mode** (without application), you can use the **UGE600 Universal Gateway** or **CO10RF coordinator** to configure the system. Please note that you cannot use both devices at the same time. Before installing the system you have to decide:

- to create a network using the **UGE600 Universal Gateway** (you can connect it to the Internet in the future)
- to create a network using the **CO10RF coordinator** (you can't connect it to the Internet)

 **REMEMBER!** The **UGE600 Universal Gateway** and **CO10RF coordinator** are two different devices. Each device creates and operates its own network.

Universal Gateway -

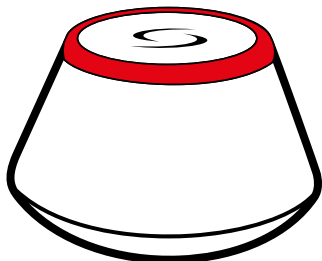

**Universal Gateway is
NOT CONNECTED TO THE INTERNET**

You can use your devices locally without the Smart Home App. Gateway works in this mode as standard ZigBee coordinator.

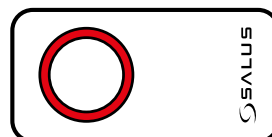

- CO10RF Coordinator

CO10RF Coordinator

You can use standard ZigBee network coordinator to install and use your devices.

NOTE: CO10RF Coordinator is included in the set with the KL08RF Control Box.

 **Please note!** If your system has been installed in the OFFLINE mode using the **UGE600 Universal Gateway** and then connected to the Internet, all devices should be found in the SALUS Smart Home application (using „Scan for equipment“ button). All devices found in the application don't need to be reconfigured, because all settings are automatically copied from the gateway.

Please note! If your system was created using the **CO10RF coordinator** and you would like to control the devices via the Internet, then all devices should be reinstalled using the UGE600 Universal Gateway.



KL08RF - Wiring Centre for 8-zone underfloor heating (UFH).



+ **extension KL04RF**



RX10RF
receiver

RX10RF reacts to HTR-RF(20) signal automatically, when it is paired with KL08RF wiring centre in heating mode. It's not possible to pair directly HTR-RF(20) with RX10RF.

7.2 Pairing with underfloor heating wiring centre (KL08RF/Control Box)

7.2.1 Available operation modes

CASE 1

GROUP 1 - consists of 4 thermostats (in addition, more thermostats can be assigned to a group in further zones located in the wiring centre). Managed by 1 weekly, programmable thermostat, configured as a MASTER (group 1), e.g. HTRP-RF (50). The other 3 thermostats are daily, non-programmable, configured as a SLAVE (group 1), e.g. HTR-RF(20) or HTRS-RF (30). The MASTER thermostat can affect the SLAVE thermostats (HTR-RF(20), HTRS-RF (30)), which will follow the schedule set on the HTRP-RF(50) thermostat. Remember - if you want MASTER thermostat to control the SLAVE thermostats, then all SLAVE thermostats have to be set to AUTO mode - **A** or NSB function jumper has to be set ON (in HTR-RF(20) case - please refer to 2.5 chapter). The HTR-RF(20) thermostat is configured as a SLAVE thermostat during pairing with the KL08RF underfloor heating wiring centre (see section 7.2.2).

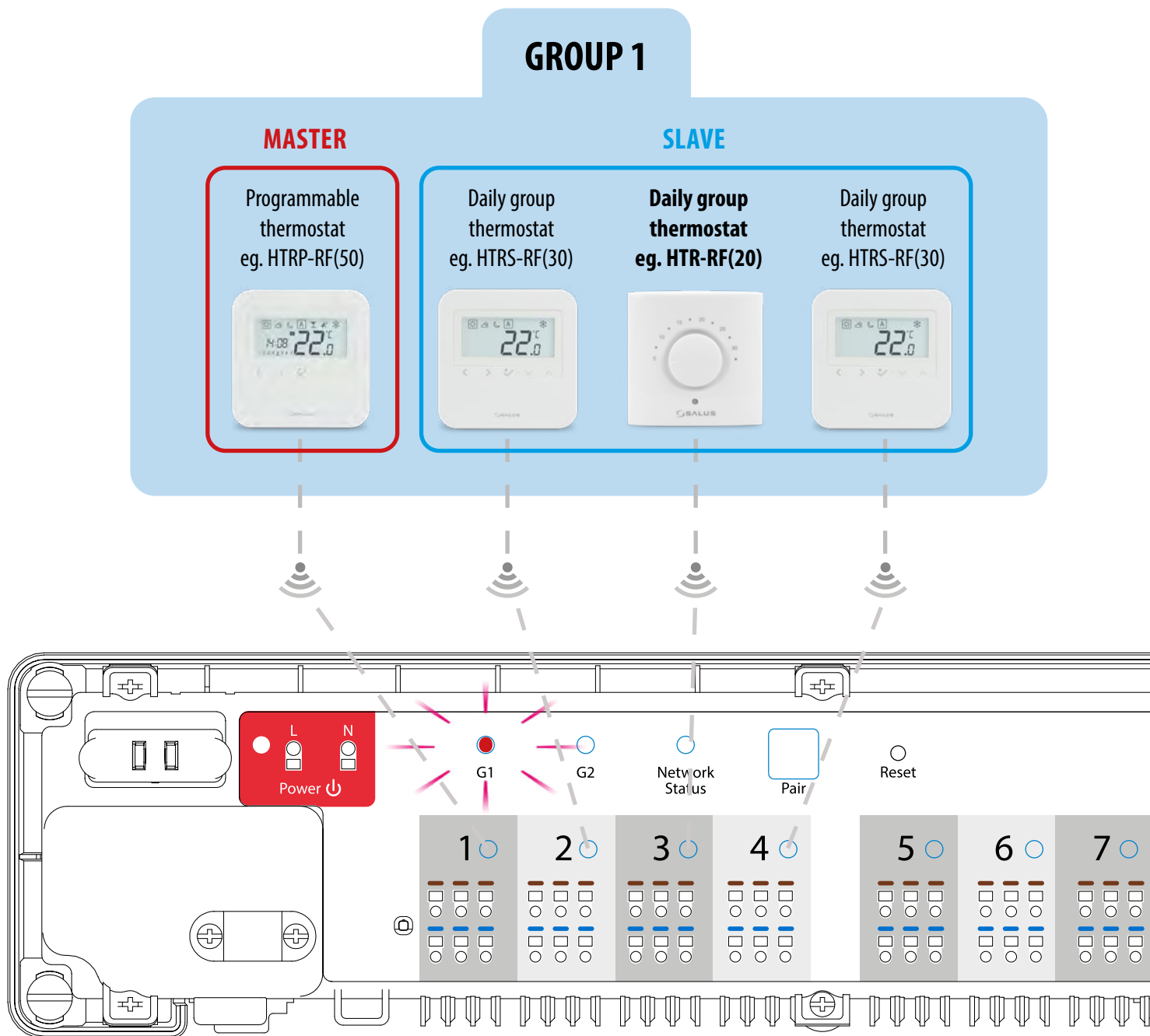

CASE 2

GROUP 2 - consists of 2 thermostats. The first thermostat is a daily, non-programmable thermostat, configured as a SLAVE (group 2), e.g. HTR-RF(20). The second thermostat is a weekly, programmable thermostat, configured as a MASTER (group 2), e.g. HTRP-RF(50). The MASTER thermostat can affect the SLAVE thermostats (HTR-RF(20)), which will follow the schedule set on the HTRP-RF(50) thermostat. Remember - if you want MASTER thermostat to control the SLAVE thermostats, then all SLAVE thermostats have to be set to AUTO mode - [A] or NSB function jumper has to be set ON (in HTR-RF(20) case - please refer to 2.5 chapter). The HTR-RF(20) thermostat is configured as a SLAVE thermostat during pairing with the KL08RF underfloor heating wiring centre (see section 7.2.2).

NOTE - you can also create the second group on the same wiring centre. The groups will operate independently of each other.

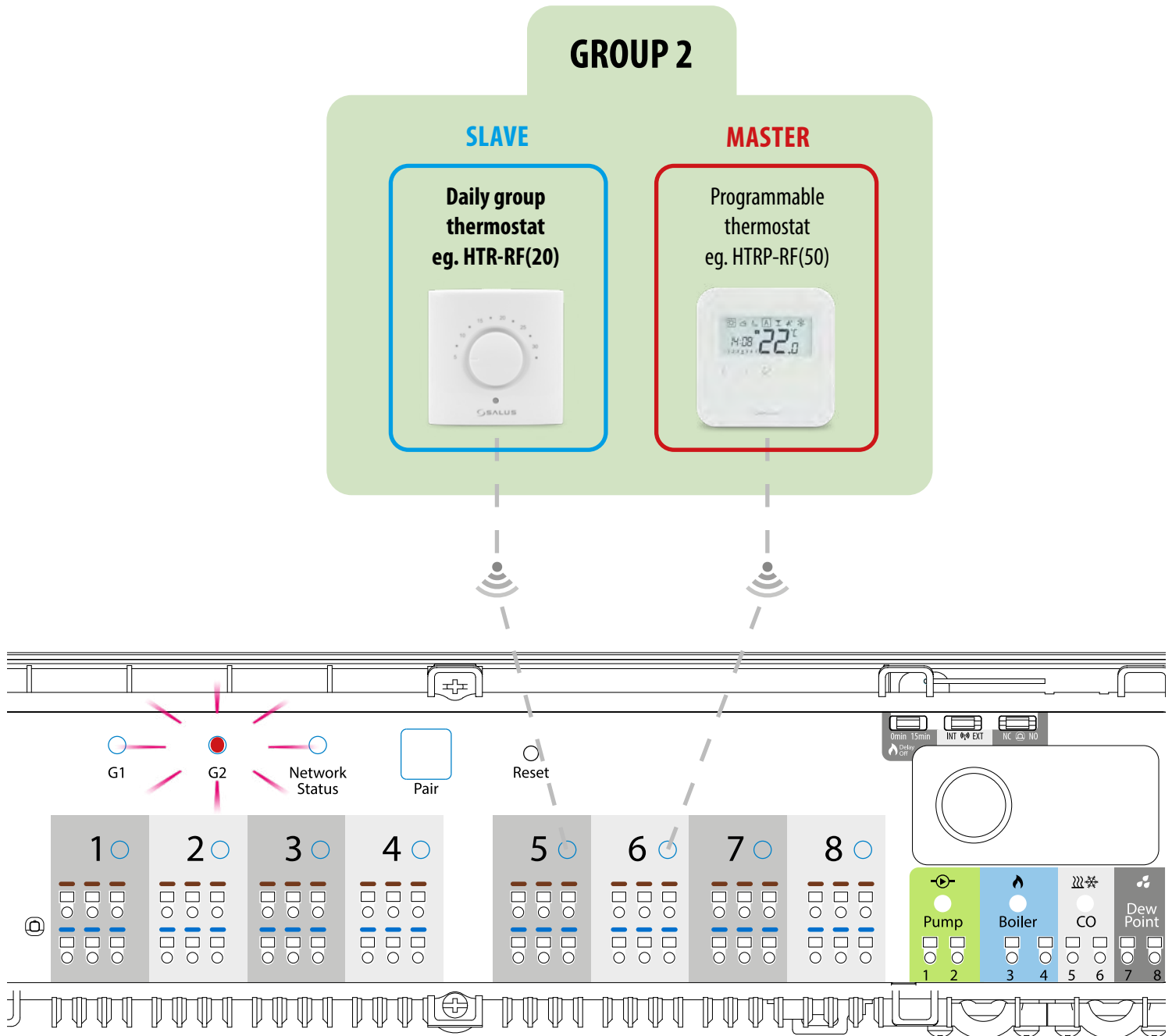

CASE 3

Daily temperature thermostat - it is a single, independent thermostat assigned to any zone on the wiring centre, configured as a regular daily, non-programmable thermostat (not MASTER, not SLAVE) for operation in manual mode. Configuration of the HTR-RF(20) thermostat as a daily temperature thermostat occurs during pairing with the KL08RF underfloor heating wiring centre (see section 7.2.2).

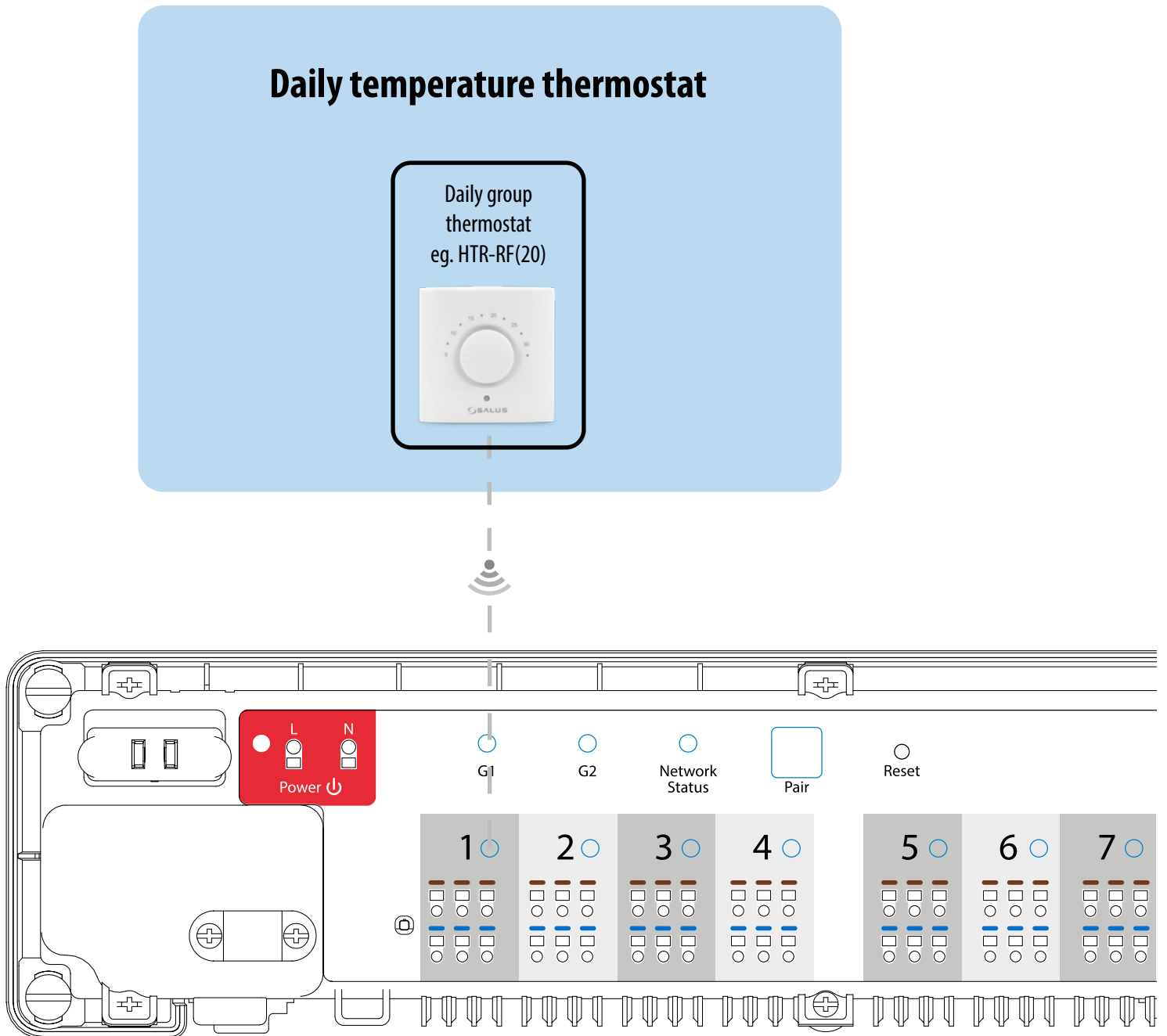

7.2.2 Pairing with underfloor heating wiring centre (KL08RF/Control Box) and installation of the thermostat as a group thermostat - SLAVE

PLEASE NOTE!

For easier installation, please make sure you have already added underfloor heating wiring centre (KL08RF/Control Box) to your ZigBee network (please refer to the underfloor heating wiring centre manual instruction).

In this chapter you will also learn how to set HTR-RF(20) as a group thermostat (SLAVE). Please look at the instructions below:

1

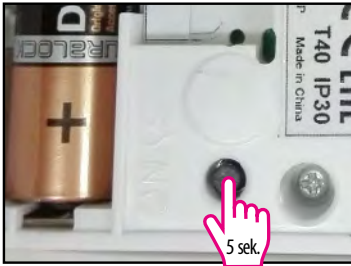

Press SYNC button (back of the thermostat) for 5 seconds...

2

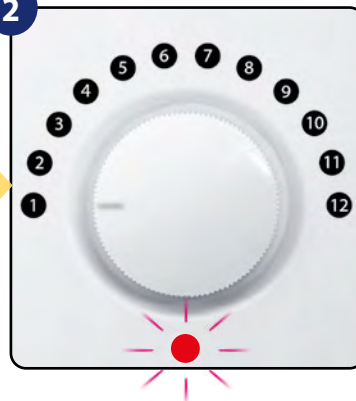

Now thermostat is looking for the signal from the coordinator and red diode will start to blink 3 times in a row sequentially....

3

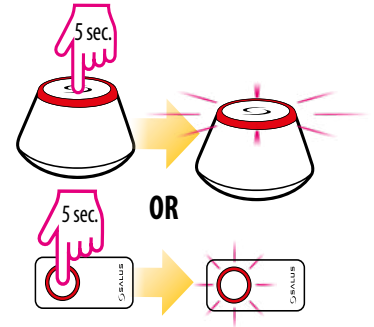

Open the ZigBee network.

4

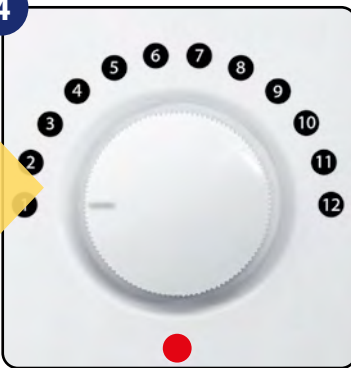

Diode will flash constantly red. Thermostat is connected.

5



Select the Control Box number (up to 9 wiring centers) using knob.
 1 Wiring Centre = 1 position
 2 Wiring Centre = 2 position
 9 Wiring Centre = 9 position

6

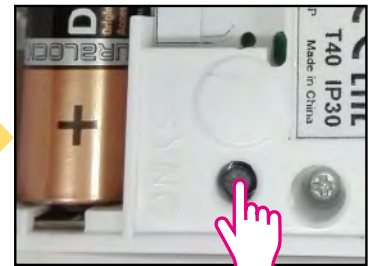

Confirm by SYNC button.

7

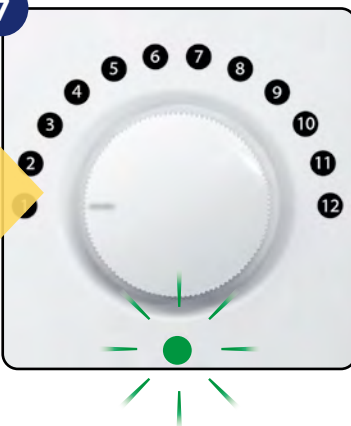

The number of green flashes of the LED confirms your choice.

8



Choose group number using knob.
 Without group = 1 position
 Group 1 = 2 position
 Group 2 = 3 position

9



Confirm by SYNC button.

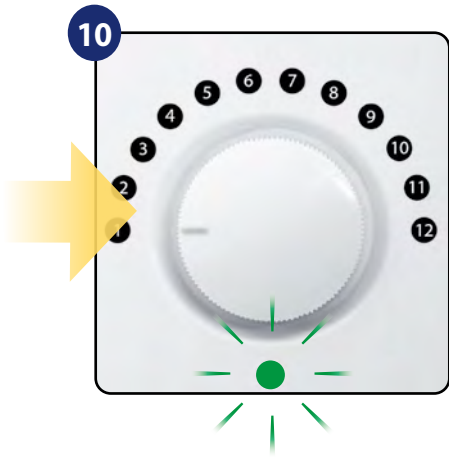

The number of **green** flashes of the LED confirms your choice.

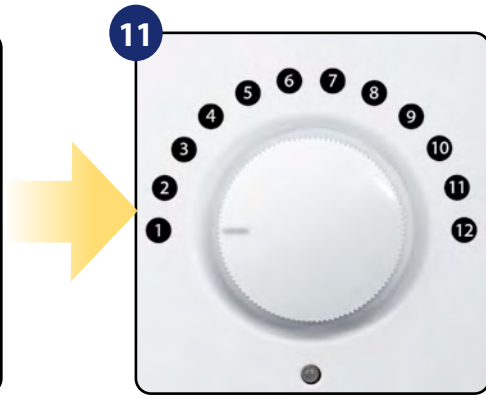

Select the wiring centre zone number (up to 12 zones) using knob.
1 Zone = 1 position
2 Zone = 2 position
12 Zone = 12 position



Confirm by SYNC button.

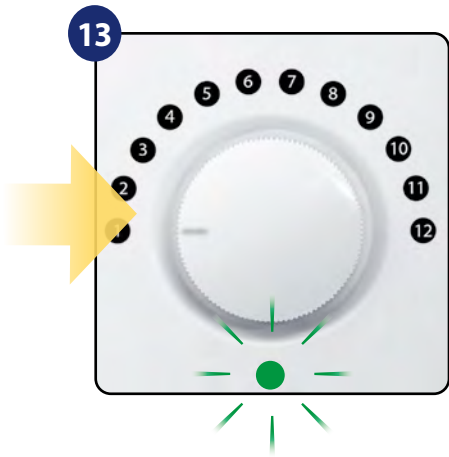

The number of **green** flashes of the LED confirms your choice.

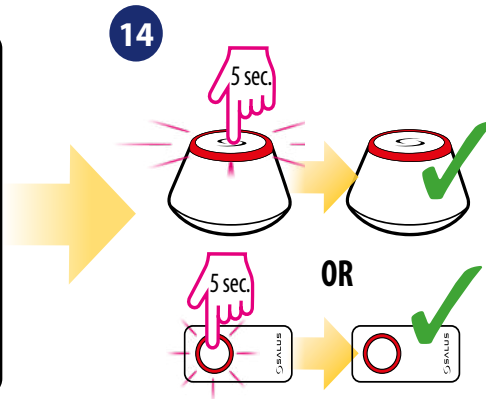

Close the ZigBee network.

8. OPERATING in OFFLINE MODE

8.1 Heat/cool mode change (KL08RF connection)

HTR-RF(20) thermostat is designed to work in heating and cooling systems. By default thermostat is set to heating mode. To change from heating to cooling mode it's necessary to insert jumper into „CO” terminal (KL08RF wiring centre). Look at the instructions below:

HEATING MODE:

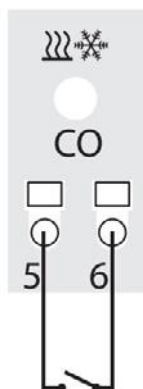

„CO” terminal of the KL08RF wiring centre - if contacts are opened, then all thermostats paired with KL08RF are in heating mode.

COOLING MODE:

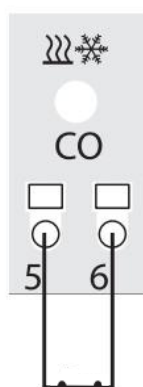

„CO” terminal of the KL08RF wiring centre - if contacts are closed, then all thermostats paired with KL08RF are in cooling mode.

9. Battery change



1 Remove back cover.



2 Remove old batteries and insert new ones. When done, place the thermostat on the back cover that is attached to the wall.

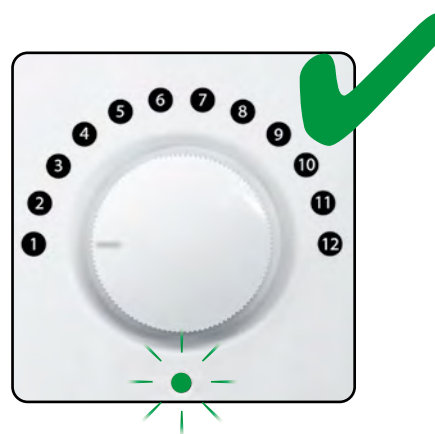
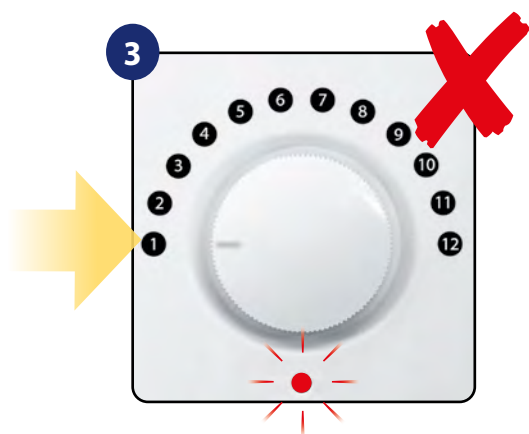

3 After inserting the batteries, the LED will turn on for 2 seconds. Red colour = device not paired, green colour = device is paired. To re-pair the device please refer to section 7.2.2.

10. Factory reset



1 Press SYNC button (back of the thermostat) for 5 seconds.

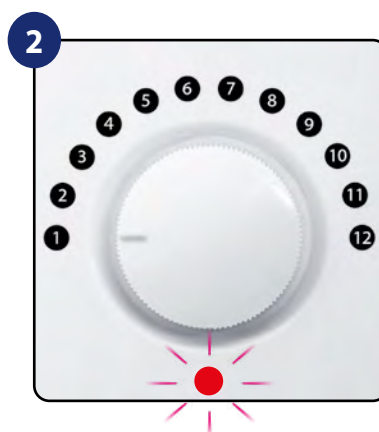

2 After restoring factory settings, the thermostat automatically enters pairing mode for up to 2 minutes. In pairing mode, the LED blinks red 3 times in sequence.

11. Cleaning and Maintenance

The **HTR-RF(20) thermostat** requires no special maintenance. Periodically, the outer casing can be wiped clean using a dry cloth (please DO NOT use solvents, polishes, detergents or abrasive cleaners, as these can damage the thermostat). There are no user serviceable parts within the unit; any servicing or repairs could only be carried out by **Salus Controls** or their appointed agents.

12. Technical Informations

Power supply	2 x AA Batteries
Temperature range	5 - 32.5°C
Control algorithm	TPI or Hysteresis: $\pm 0.25^{\circ}\text{C}$
Communication	ZigBee 2,4 GHz
Dimension [mm]	80 x 80 x 35

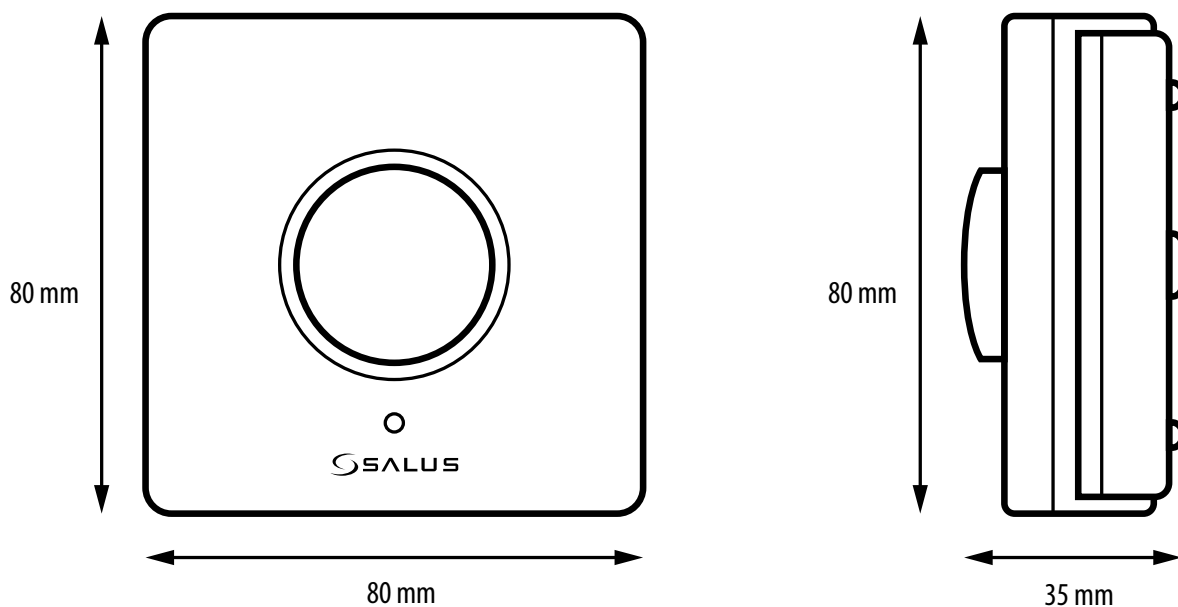

13. Warranty

SALUS CONTROLS warrants this product to be free from any defects in material or workmanship and to perform as specified for a period of five years from the date of installation. SALUS CONTROLS reserves the sole responsibility for breach of this warranty by repairing or replacing the defective product. This product includes software that matches the distributor's identification at the time of sale. The manufacturer / distributor provides a guarantee covering all functions and specifics of the product in accordance with this marking. The distributor's warranty does not cover the correct operation of the functions and features available as a result of a product software update.

The full warranty conditions are available at www.salus-controls.eu

Customer Name:
Customer Address:
..... Post Code:
Tel No: Email:
Company Name:
Tel No: Email:
Installation Date:
Installer Name:
Installer Signature:

IMPORTER:

QL CONTROLS Sp. z o.o. Sp. k.
ul. Rolna 4, 43-262 Kobielice

PRODUCER:

Salus Limited
6/F, Building 20E, Phase 3, Hong Kong Science
Park, 20 Science Park East Avenue, Shatin,
New Territories, Hong Kong



www.salus-controls.com

SALUS Controls is a member of the Computime Group.

Maintaining a policy of continuous product development SALUS Controls plc reserve the right to change specification, design and materials of products listed in this brochure without prior notice.

Ver. 4

Issued: 31 III 2020

